



## EMC TEST REPORT

**Certificate No.** : TBC-C-202601-0040-3  
**Report No.** : TBR-C-202601-0040-99  
**Applicant** : Heltec Automation Technology Co., Ltd  
**Equipment Under Test (EUT)**  
**EUT Name** : WiFi LoRa 32  
**Model No.** : HTIT-WBR2H  
**Series Model No.** : HTIT-WB32LAF, HTIT-WBR2N, HTIT-WBR8H, HTIT-WBR8N, HTIT-WBR8G, HTIT-WBN8G, HTIT-WBR2G, HTIT-WB32A, HTIT-WB32B, HTIT-WB32C, HTIT-WB32S, HTIT-WB32E1, HTIT-WB32E2, HTIT-WB32E3, HTIT-WB32E4, HTIT-WBNRT1, HTIT-WBNRT2  
**Brand Name** : Heltec Automation  
**Receipt Date** : 2026-04-09  
**Test Date** : 2026-04-09 to 2026-05-19  
**Issue Date** : 2026-05-20  
**Standards** : ETSI EN 301 489-1 V2.2.3:2019  
ETSI EN 301 489-3 V2.3.2:2023  
ETSI EN 301 489-17 V3.3.1:2024  
**Conclusions** : **PASS**

In the configuration tested, the EUT complied with the standards specified above. The EUT technically complies with the Council Directive 2014/53/EU relating to radio equipment.

**Tested By** : hao.he

**Reviewed By** : Wade.Lv

**Approved By** : Ivan Su

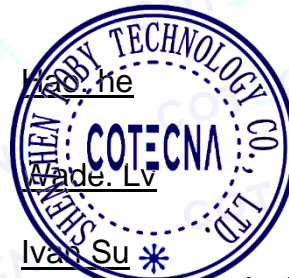

This report details the results of the testing carried out on one sample. The results contained in this test report do not relate to other samples of the same product. The manufacturer should ensure that all products in series production are in conformity with the product sample detailed in the report.

TB-RF-073-3.1

**TABLE OF CONTENTS**

**1 GENERAL INFORMATION .....5**

1.1 Client Information .....5

1.2 General Description of EUT (Equipment Under Test) .....5

1.3 Block Diagram Showing the Configuration of System Tested .....6

1.4 Description of Support Units .....6

1.5 Description of Operating Mode .....7

1.6 Performance Criteria .....8

1.7 Measurement Uncertainty .....12

1.8 Test Facility .....12

**2 TEST RESULTS SUMMARY .....13**

**3 TEST SOFTWARE.....14**

**4 TEST EQUIPMENT AND TEST SITE.....15**

**5 CONDUCTED DISTURBANCE TEST (AC PORT).....17**

5.1 Test Standard and Limit.....17

5.2 Test Setup .....17

5.3 Test Procedure .....18

5.4 Deviation From Test Standard .....18

5.5 Test Data .....18

**6 CONDUCTED EMISSIONS (WIRED NETWORK PORT).....19**

6.1 Test Standard and Limit.....19

6.2 Test Setup .....20

6.3 Test Procedure .....21

6.4 Deviation From Test Standard .....21

6.5 Test Data .....21

**7 RADIATED EMISSION TEST .....22**

7.1 Test Standard and Limit.....22

7.2 Test Setup .....23

7.3 Test Procedure .....24

7.4 Deviation From Test Standard .....24

7.5 Test Data .....24

**8 HARMONIC CURRENT EMISSION TEST .....25**

8.1 Test Standard and Limit.....25

8.2 Test Setup .....25

8.3 Test Procedure .....25

8.4 Deviation From Test Standard .....26

8.5 Test Data .....26

**9 VOLTAGE FLUCTUATION AND FLICKER TEST .....27**

9.1 Test Standard and Limit.....27

9.2 Test Setup .....27

9.3 Test Procedure .....27

9.4 Deviation From Test Standard .....27

9.5 Test Data .....27

**10 ELECTROSTATIC DISCHARGE IMMUNITY TEST .....28**

10.1 Test Standard and Limit .....28

10.2 Test Procedure .....28

10.3 Deviation From Test Standard .....29



10.4	Test Data.....	29
<b>11</b>	<b>RADIATED ELECTROMAGNETIC FIELD IMMUNITY TEST.....</b>	<b>30</b>
11.1	Test Standard and Limit .....	30
11.2	Test Setup.....	30
11.3	Test Procedure.....	31
11.4	Deviation From Test Standard.....	31
11.5	Test Data.....	31
<b>12</b>	<b>ELECTRICAL FAST TRANSIENT/BURST TEST.....</b>	<b>32</b>
12.1	Test Standard and Limit .....	32
12.2	Test Setup.....	32
12.3	Test Procedure.....	32
12.4	Deviation From Test Standard.....	33
12.5	Test Data.....	33
<b>13</b>	<b>SURGE IMMUNITY TEST .....</b>	<b>34</b>
13.1	Test Standard and Limit .....	34
13.2	Test Setup.....	34
13.3	Test Procedure.....	34
13.4	Deviation From Test Standard.....	34
13.5	Test Data.....	34
<b>14</b>	<b>RF COMMON MODE.....</b>	<b>35</b>
14.1	Test Standard and Limit .....	35
14.2	Test Setup.....	35
14.2	Test Procedure.....	35
14.3	Deviation From Test Standard.....	36
14.4	Test Data.....	36
<b>15</b>	<b>VOLTAGE DIPS AND INTERRUPTIONS IMMUNITY TEST .....</b>	<b>37</b>
15.1	Test Standard and Limit .....	37
15.2	Test Setup.....	37
15.2	Test Procedure.....	37
15.3	Deviation From Test Standard.....	37
15.4	Test Data.....	37
<b>16</b>	<b>PHOTOGRAPHS--CONSTRUCTIONAL DETAILS .....</b>	<b>38</b>
<b>17</b>	<b>PHOTOGRAPHS--TEST SETUP .....</b>	<b>49</b>
	<b>ATTACHMENT A--CONDUCTED EMISSION DATA (AC MAINS) .....</b>	<b>53</b>
	<b>ATTACHMENT B--RADIATED EMISSION TEST DATA .....</b>	<b>55</b>
	<b>ATTACHMENT C--ELECTROSTATIC DISCHARGE TEST DATA.....</b>	<b>59</b>
	<b>ATTACHMENT D--RF FIELD STRENGTH SUSCEPTIBILITY TEST DATA.....</b>	<b>61</b>
	<b>ATTACHMENT E--ELECTRICAL FAST TRANSIENT/BURST TEST DATA.....</b>	<b>62</b>
	<b>ATTACHMENT F--SURGE IMMUNITY TEST DATA.....</b>	<b>63</b>
	<b>ATTACHMENT G--CONDUCTED IMMUNITY TEST DATA.....</b>	<b>64</b>
	<b>ATTACHMENT H--VOLTAGE DIPS AND INTERRUPTIONS TEST DATA .....</b>	<b>65</b>





# 1 General Information

## 1.1 Client Information

<b>Applicant</b>	:	Heltec Automation Technology Co., Ltd
<b>Address</b>	:	1f, No. 54, 56, 58, Zirui North Street, Gaoxin District, Chengdu, China
<b>Manufacturer</b>	:	Heltec Automation Technology Co., Ltd
<b>Address</b>	:	1f, No. 54, 56, 58, Zirui North Street, Gaoxin District, Chengdu, China

## 1.2 General Description of EUT (Equipment Under Test)

<b>EUT Name</b>	:	WiFi LoRa 32
<b>Model(s)</b>	:	HTIT-WBR2H, HTIT-WB32LAF, HTIT-WBR2N, HTIT-WBR8H, HTIT-WBR8N, HTIT-WBR8G, HTIT-WBN8G, HTIT-WBR2G, HTIT-WB32A, HTIT-WB32B, HTIT-WB32C, HTIT-WB32S, HTIT-WB32E1, HTIT-WB32E2, HTIT-WB32E3, HTIT-WB32E4, HTIT-WBNRT1, HTIT-WBNRT2
<b>Model Difference</b>	:	All these models are identical in the same PCB layout and electrical circuit, only difference is model name.
<b>Product Description</b>	:	Operation Frequency: Bluetooth LE: 2402MHz~2480MHz 2.4G WIFI: 2412MHz~2472MHz LoRa: 863MHz~870MHz
<b>Power Rating</b>	:	INPUT: DC 5.0V
<b>Software Version</b>	:	N/A
<b>Hardware Version</b>	:	N/A
<b>Remark:</b> The antenna gain provided by the applicant, the verified for the RF conduction test provided by TOBY test lab.		

**Note:**

- (1) For a more detailed features description, please refer to the manufacturer's specifications or the User's Manual.



### 1.3 Block Diagram Showing the Configuration of System Tested

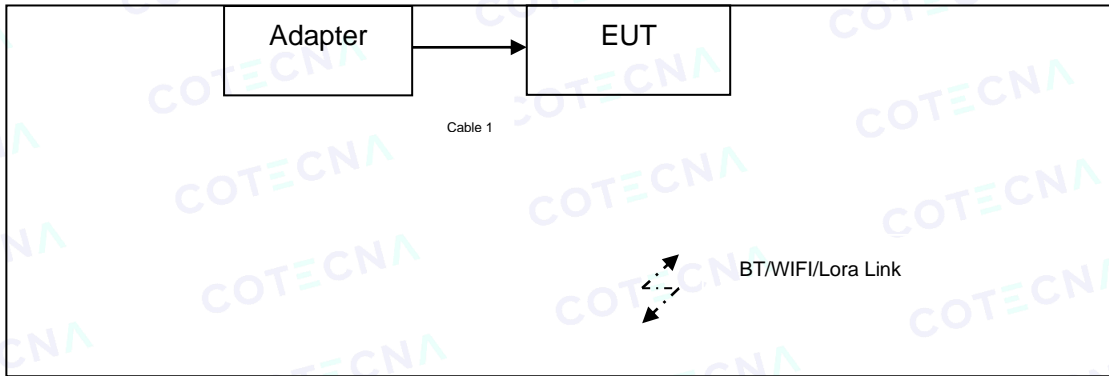

### 1.4 Description of Support Units

Equipment Information				
Name	Model	S/N	Manufacturer	Used “√”
Adapter	HW-100225C00	-----	HUAWEI	√
Cable Information				
Number	Shielded Type	Ferrite Core	Length	Note
Cable1	-----	-----	0.8M	-----
Remark: The adapter and cable is provided by Toby test lab.				



### 1.5 Description of Operating Mode

To investigate the maximum EMI emission characteristics generated from EUT, the test system was pre-scanning tested based on the consideration of following EUT operation mode or test configuration mode which possible have effect on EMI emission level. Each of these EUT operation mode(s) or test configuration mode(s) mentioned above was evaluated respectively.

Pretest Mode	Description
Mode 1	Bluetooth Link
Mode 2	2.4G WIFI Link
Mode 3	LoRa Link

The EUT system operated these modes were found to be the worst case during the pre-scanning test as Following:

For EMI Test	
Final Test Mode	Description
Mode 1	Bluetooth Link
Mode 2	2.4G WIFI Link
Mode 3	LoRa Link
For EMS Test	
Final Test Mode	Description
Mode 1	Bluetooth Link
Mode 2	2.4G WIFI Link
Mode 3	LoRa Link



## 1.6 Performance Criteria

### ETSI EN 301 489-1

#### (1) Introduction

The performance criteria are used to take a decision on whether a radio equipment passes or fails immunity tests. For the purpose of the present document two categories of performance criteria apply:

- Performance criteria for continuous phenomena.
- Performance criteria for transient phenomena.

NOTE: Normally, the performance criteria depends upon the type of radio equipment and/or its intended application. Thus, the present document only contains general performance criteria commonly used for the assessment of radio equipment.

#### (2) Performance criteria for continuous phenomena

During the test, the equipment shall:

- continue to operate as intended;
- not unintentionally transmit;
- not unintentionally change its operating state;
- not unintentionally change critical stored data.

#### (3) Performance criteria for transient phenomena

For all ports and transient phenomena with the exception described below, the following applies:

- The application of the transient phenomena shall not result in a change of the mode of operation (e.g. unintended transmission) or the loss of critical stored data.
- After application of the transient phenomena, the equipment shall operate as intended.

For surges applied to symmetrically operated wired network ports intended to be connected directly to outdoor lines the following criteria applies:

- For products with only one symmetrical port intended for connection to outdoor lines, loss of function is allowed, provided the function is self-recoverable, or can be otherwise restored. Information stored in non-volatile memory, or protected by a battery backup, shall not be lost.
- For products with more than one symmetrical port intended for connection to outdoor lines, loss of function on the port under test is allowed, provided the function is self-recoverable. Information stored in non-volatile memory, or protected by a battery backup, shall not be lost.



**ETSI EN 301 489-3**

According to **EN 301 489-3** standard, the general performance criteria as following:

- performance criterion A applies for immunity tests with phenomena of a continuous nature;
- performance criterion B applies for immunity tests with phenomena of a transient nature.

**NOTE:** Whether a phenomenon is considered transient, continuous or otherwise is indicated in the test procedures for the phenomenon in ETSI EN 301 489-1 [1], clause 9.

**Performance Requirements**

Criterion	During test	After test
A	Operate as intended No loss of function No unintentional responses	Operate as intended No loss of function No degradation of performance No loss of stored data or user programmable functions
B	May show loss of function No unintentional responses	Operate as intended Lost function(s) shall be self-recoverable No degradation of performance No loss of stored data or user programmable functions

**The Requirement of Performance Criteria**

1	Performance criteria for continuous phenomena applied to transmitters (CT)	Criterion A of the applicable class shall apply
2	Performance criteria for transient phenomena applied to transmitters (TT)	Criterion B of the applicable class shall apply
3	Performance criteria for continuous phenomena applied to receivers (CR)	Criterion A of the applicable class shall apply
4	Performance criteria for transient phenomena applied to transmitters (TR)	Criterion B of the applicable class shall apply



**ETSI EN 301 489-17**

**(1) General performance criteria**

The performance criteria are:

- performance criteria A for immunity tests with phenomena of a continuous nature;
- performance criteria B for immunity tests with phenomena of a transient nature;
- performance criteria C for immunity tests with power interruptions exceeding a certain time.

time.

The equipment shall meet the minimum performance criteria as specified in the following clauses.

**(2) Performance table**

A, Performance criteria overview

<b>Table 1: Performance criteria</b>		
<b>Criterion</b>	<b>During Test</b>	<b>After test (i.e. as a result of the application of the test)</b>
A	Shall operate as intended. (see note). Shall be no loss of function. Shall be no unintentional transmissions.	Shall operate as intended. Shall be no degradation of performance. Shall be no loss of function. Shall be no loss of critical stored data.
B	May be loss of function.	Functions shall be self-recoverable. Shall operate as intended after recovering. Shall be no loss of critical stored data.
C	May be loss of function.	Functions shall be recoverable by the operator. Shall operate as intended after recovering. Shall be no loss of critical stored data.

NOTE: Operate as intended during the test allows a level of degradation in accordance with clause 6.2.2.

B, Performance criteria overview

For equipment that supports a PER or FER, the minimum performance level shall be a PER or FER less than or equal to 10 %.

For equipment that does not support a PER or a FER, the minimum performance level shall be no loss of the wireless transmission function needed for the intended use of the equipment.

**(3) Performance criteria for Continuous phenomena applied to Transmitters (CT)**

The performance criteria A shall apply.

Tests shall be repeated with the EUT in standby mode (if applicable) to ensure that unintentional transmission does not occur. In systems using acknowledgement signals, it is recognized that an ACKnowledgement (ACK) or Not ACKnowledgement (NACK) transmission may occur, and steps should be taken to ensure that any transmission

resulting from the application of the test is correctly interpreted.



**(4) Performance criteria for Transient phenomena applied to Transmitters (TT)**

The performance criteria B shall apply, except for voltage dips of 100 ms and voltage interruptions of 5 000 ms duration, for which performance criteria C shall apply.

Tests shall be repeated with the EUT in standby mode (if applicable) to ensure that unintentional transmission does not occur. In systems using acknowledgement signals, it is recognized that an acknowledgement (ACK) or not-acknowledgement (NACK) transmission may occur, and steps should be taken to ensure that any transmission resulting from the application of the test is correctly interpreted.

**(5) Performance criteria for Continuous phenomena applied to Receivers (CR)**

The performance criteria A shall apply.

Where the EUT is a transceiver, under no circumstances, shall the transmitter operate unintentionally during the test. In systems using acknowledgement signals, it is recognized that an ACK or NACK transmission may occur, and steps should be taken to ensure that any transmission resulting from the application of the test is correctly interpreted.

**(6) Performance criteria for Transient phenomena applied to Receivers (TR)**

The performance criteria B shall apply, except for voltage dips of 100 ms and voltage interruptions of 5 000 ms duration for which performance criteria C shall apply.

Where the EUT is a transceiver, under no circumstances, shall the transmitter operate unintentionally during the test. In systems using acknowledgement signals, it is recognized that an ACK or NACK transmission may occur, and steps should be taken to ensure that any transmission resulting from the application of the test is correctly interpreted.



## 1.7 Measurement Uncertainty

The reported uncertainty of measurement  $y \pm U$ , where expanded uncertainty  $U$  is based on a standard uncertainty multiplied by a coverage factor of  $k=2$ , providing a level of confidence of approximately 95 %.

Test Item	Expanded Uncertainty ( $U_{Lab}$ )
Conducted Emission	$\pm 3.50$ dB
Radiated Emission (9kHz to 30 MHz)	$\pm 4.60$ dB
Radiated Emission (30MHz to 1000 MHz)	$\pm 4.60$ dB
Radiated Emission (Above 1000MHz)	$\pm 4.50$ dB
Temperature	$\pm 0.6$ °C
Humidity	$\pm 4$ %

## 1.8 Test Facility

The testing report were performed by the Shenzhen Toby Technology Co., Ltd., in their facilities located at 1/F., Building 6, Rundongsheng Industrial Zone, Longzhu, Xixiang, Bao'an District, Shenzhen, Guangdong, China. At the time of testing, the following bodies accredited the Laboratory:

### **CNAS (L5813)**

The Laboratory has been accredited by CNAS to ISO/IEC 17025: 2017 General Requirements for the Competence of Testing and Calibration Laboratories for the competence in the field of testing. And the Registration No.: CNAS L5813.

### **A2LA Certificate No.: 4750.01**

The laboratory has been accredited by American Association for Laboratory Accreditation(A2LA) to ISO/IEC 17025: 2017 General Requirements for the Competence of Testing and Calibration Laboratories for the technical competence in the field of Electrical Testing. And the A2LA Certificate No.: 4750.01.FCC Accredited Test Site Number: 854351. Designation Number: CN1223.

### **IC Registration No.: (11950A)**

The Laboratory has been registered by Certification and Engineering Bureau of Industry Canada for radio equipment testing. The site registration: Site# 11950A. CAB identifier: CN0056.



## 2 Test Results Summary

Test procedures according to the technical standards:

<b>Requirement Standard:</b>	ETSI EN 301 489-1 V2.2.3:2019 ETSI EN 301 489-3 V2.3.2:2023 ETSI EN 301 489-17 V3.3.1:2024			
EMC Emission				
Test Standard	Test Item	Limit	Result	Remark
EN 55032:2015+A11:2020+A1:2020	Conducted Emission	Class B	PASS	
	Radiated Emission	Class B	PASS	
EN IEC 61000-3-2:2019+A2:2024	Harmonic Current Emission	Class A	N/A	Note(2)
EN 61000-3-3:2013+A2:2021	Voltage Fluctuations & Flicker		N/A	
EMC Immunity				
Test Standard	Test Item	Performance Criteria	Result	Remark
EN 61000-4-2:2009	Electrostatic Discharge	B (TT,TR)	PASS	
EN IEC 61000-4-3:2020	RF electromagnetic field	A (CT,CR)	PASS	
EN 61000-4-4:2012	Fast transients	B (TT,TR)	PASS	
EN 61000-4-5:2014+A1:2017	Surges	B (TT,TR)	PASS	
EN IEC 61000-4-6:2023	Injected Current	A (CT,CR)	PASS	
EN IEC 61000-4-11:2020	Volt. Interruptions Volt. Dips	B /B/ C / C NOTE (3)	PASS	
<b>NOTE:</b>				
	(1) " N/A" denotes test is not applicable in this Test Report			
	(2) The power consumption of EUT is less than 75W and no Limits apply.			
	(3) Voltage dip: 0% residual 0.5 cycle– Performance Criteria B (TT,TR)			
	Voltage dip: 0% residual 1 cycle– Performance Criteria B (TT,TR)			
	Voltage dip: 70% residual 25 cycles – Performance Criteria C			
	Voltage Interruption: 0% residual voltage 250 cycles – Performance Criteria C			
	● in the case where the equipment is fitted with or connected to a battery back-up, the performance criteria for transient phenomena shall apply ; ● in the case where the equipment is powered solely from the AC mains supply (without the use of a parallel battery back-up) volatile user data may have been lost and if applicable the communication link need not to be maintained and lost functions should be recoverable by user or operator			
	(4) The performance criteria for continuous phenomena shall apply(CT,CR). The performance criteria for transient phenomena shall apply (TT,TR).			
	(5) Monitoring of EUT for all immunity test: <b>Audio:</b> The measure acoustic interference ratio and/or the measured electrical interference ratio during the test shall be -20dB or better. <b>Visual:</b> Monitor the operating status via watching the monitor. <b>Radio:</b> The measure PER during the test shall be less than 10%.			



### 3 Test Software

Test Item	Test Software	Manufacturer	Version No.
Conducted Emission	EZ-EMC	EZ	Ver.EMC-CON3A1.1+
Radiation Emission	EZ-EMC	EZ	Ver.GARAD-3A1.1+
Radiation Emission	EZ-EMC	EZ	Ver.GARAD-3A1.1+
Radiation Immunity	TS+(J32-RS)	Tonsced	5.0.0
Harmonic Current	CTS4	CI	4.24.0
Voltage Fluctuation and Flicker	CTS4	CI	4.24.0
Conducted Immunity	IEC/EN 61000-6-4 Application	FRANKONIA	1.1.1
Electrical Fast Transient	lec.control	Nemtest	5.1.1.0
Surge	lec.control	Nemtest	5.1.1.0
Voltage Dip and Interruption	lec.control	Nemtest	5.1.1.0



## 4 Test Equipment and Test Site

Test Site				
No.	Test Site	Manufacturer	Specification	Used
TB-EMCSR001	Shielding Chamber #1	YIHENG	7.5*4.0*3.0 (m)	√
TB-EMCSR002	Shielding Chamber #2	YIHENG	8.0*4.0*3.0 (m)	X
TB-EMCCA001	3m Anechoic Chamber #A	ETS	9.0*6.0*6.0 (m)	X
TB-EMCCB002	3m Anechoic Chamber #B	YIHENG	9.0*6.0*6.0 (m)	√

Conducted Emission Test					
Equipment	Manufacturer	Model No.	Serial No.	Last Cal.	Cal. Due Date
EMI Test Receiver	Rohde & Schwarz	ESCI	100321	Jun. 16, 2025	Jun. 15, 2026
RF Switching Unit	Compliance Direction Systems Inc	RSU-A4	34403	Jun. 16, 2025	Jun. 15, 2026
AMN	SCHWARZBECK	NNBL 8226-2	8226-2/164	Jun. 16, 2025	Jun. 15, 2026
LISN	Rohde & Schwarz	ENV216	101131	Jun. 16, 2025	Jun. 15, 2026

Radiation Emission Test (B Site)					
Equipment	Manufacturer	Model No.	Serial No.	Last Cal.	Cal. Due Date
Spectrum Analyzer	Agilent	N9020A	MY49100060	Aug. 27, 2025	Aug. 26, 2026
Spectrum Analyzer	Rohde & Schwarz	FSV40-N	102197	Jun. 16, 2025	Jun. 15, 2026
EMI Test Receiver	Rohde & Schwarz	ESU-8	100472/008	Jan. 30, 2026	Jan. 29, 2027
Bilog Antenna	SCHWARZBECK	VULB 9168	1225	Oct. 18, 2025	Oct. 17, 2027
Horn Antenna	SCHWARZBECK	BBHA 9120 D	2463	Jun. 14, 2024	Jun. 13, 2026
Horn Antenna	SCHWARZBECK	BBHA 9170	1118	Jan. 31, 2026	Jan. 30, 2028
Loop Antenna	SCHWARZBECK	FMZB 1519 B	1519B-059	Jan. 04, 2026	Jan. 03, 2028
HF Amplifier	Tonscend	TAP9E6343	AP21C806117	Aug. 27, 2025	Aug. 26, 2026
HF Amplifier	Tonscend	TAP051845	AP21C806141	Aug. 27, 2025	Aug. 26, 2026
HF Amplifier	Tonscend	TAP0184050	AP21C806129	Aug. 27, 2025	Aug. 26, 2026

Harmonic Current and Voltage Fluctuation and Flicker Test					
Equipment	Manufacturer	Model No.	Serial No.	Last Cal.	Cal. Due Date
Harmonic Flicker Test System	CI	5001ix-CTS-400	100321	Jun. 16, 2025	Jun. 15, 2026
AC Power Source	CI	500liX	59468	Jun. 16, 2025	Jun. 15, 2026

Discharge Immunity Test					
Equipment	Manufacturer	Model No.	Serial No.	Last Cal.	Cal. Due Date
ESD Tester	TESEQ	NSG437	304	Jan. 04, 2026	Jan. 03, 2027



<b>Radiated Immunity Test</b>					
<b>Equipment</b>	<b>Manufacturer</b>	<b>Model No.</b>	<b>Serial No.</b>	<b>Last Cal.</b>	<b>Cal. Due Date</b>
Gestockte Log.-Per.-Breitband-antenna Stacked Log.-Per.-Broadband	SCHWARZBECK	STLP 9129	162	N/A	N/A
Electric field probe	Narda	EP 601	811ZX01000	Feb. 03, 2026	Feb.02, 2027
Signal Generator	Agilent	N5181A	MY50141953	Aug. 27, 2025	Aug. 26, 2026
EPM Series Power Meter	KEYSIGHT	N1914A	MY61180020	Jun. 16, 2025	Jun. 15, 2026
Power Sensor	KEYSIGHT	E9301A	MY61130007	Jun. 16, 2025	Jun. 15, 2026
Power Sensor	KEYSIGHT	E9301A	MY61130011	Jun. 16, 2025	Jun. 15, 2026
Radio Frequency Switch	Tonscend	JS0806s	21E8060428	N/A	N/A
Microwave Power amplifier	Micotop	MPA-80-1000-250	MPA2105144	Jun. 16, 2025	Jun. 15, 2026
Microwave Power amplifier	Micotop	MPA-1000-6000-100	MPA2105150	Jun. 16, 2025	Jun. 15, 2026
<b>Electrical Fast Transient/ Surge/ Voltage Dip and Interruption Test</b>					
<b>Equipment</b>	<b>Manufacturer</b>	<b>Model No.</b>	<b>Serial No.</b>	<b>Last Cal.</b>	<b>Cal. Due Date</b>
Simulator	EMTEST	UCS500N5	V0948105575	Jun. 16, 2025	Jun. 15, 2026
Auto-transformer	EMTEST	V4780S2	0109-41	Jun. 16, 2025	Jun. 15, 2026
Coupling Clamp	EMTEST	HFK	1109-04	Jun. 16, 2025	Jun. 15, 2026
Combined wave surge simulator	3ctest	1000CM	ES058001920002	Aug. 27, 2025	Aug. 26, 2026
Combined wave surge simulator	3ctest	1000MM	ES058002020002	Aug. 27, 2025	Aug. 26, 2026
External 10KV single-phase coupling /decoupling network	3ctest	SPN2216S10	ES071002020001	Aug. 27, 2025	Aug. 26, 2026
CDN	3ctest	CDN405T8A1	ES2731916	Aug. 27, 2025	Aug. 26, 2026
CDN	3ctest	CDN405AF8	ES064000220008	Aug. 27, 2025	Aug. 26, 2026
<b>Conducted Immunity Test</b>					
<b>Equipment</b>	<b>Manufacturer</b>	<b>Model No.</b>	<b>Serial No.</b>	<b>Last Cal.</b>	<b>Cal. Due Date</b>
RF Generator	FRANKONIA	CIT-10/75	126B1126	Jun. 16, 2025	Jun. 15, 2026
Attenuator	FRANKONIA	59-6-33	A413	Jun. 16, 2025	Jun. 15, 2026
M-CDN	LUTHI	L-801 M2/M3	2599	Jun. 16, 2025	Jun. 15, 2026
AF2-CDN	LUTHI	L-801:AF2	2538	Jan. 30, 2026	Jan. 29, 2027
EM Injection Clamp	LUTHI	EM101	35958	Jun. 16, 2025	Jun. 15, 2026



## 5 Conducted Disturbance Test (AC Port)

### 5.1 Test Standard and Limit

#### 5.1.1 Test Standard

**ETSI EN 301 489-1 Clause 8.4**  
**ETSI EN 301 489-3 & ETSI EN 301 489-17**  
**EN 55032:2015+A11:2020+A1:2020**

#### 5.1.2 Test Limit

**Table A.9 – Requirements for conducted emissions from the AC mains power ports of Class A equipment**

Applicable to				
1. AC mains power ports (3.1.1)				
Table clause	Frequency range MHz	Coupling device (see Table A.8)	Detector type / bandwidth	Class A limits dB(μV)
A9.1	0,15 to 0,5	AMN	Quasi Peak / 9 kHz	79
	0,5 to 30			73
A9.2	0,15 to 0,5	AMN	Average / 9 kHz	66
	0,5 to 30			60

Apply A9.1 and A9.2 across the entire frequency range.

**Table A.10 – Requirements for conducted emissions from the AC mains power ports of Class B equipment**

Applicable to				
1. AC mains power ports (3.1.1)				
Table clause	Frequency range MHz	Coupling device (see Table A.8)	Detector type / bandwidth	Class B limits dB(μV)
A10.1	0,15 to 0,5	AMN	Quasi Peak / 9 kHz	66 to 56
	0,5 to 5			56
	5 to 30			60
A10.2	0,15 to 0,5	AMN	Average / 9 kHz	56 to 46
	0,5 to 5			46
	5 to 30			50

Apply A10.1 and A10.2 across the entire frequency range.

### 5.2 Test Setup

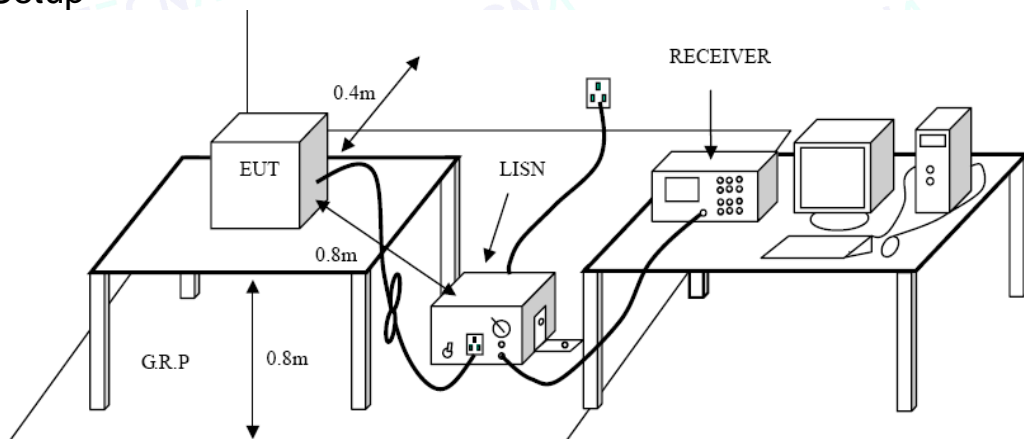

### 5.3 Test Procedure

The EUT was placed 0.8 meters from the horizontal ground plane with EUT being connected to the power mains through a line impedance stabilization network (LISN). All other support equipments powered from additional LISN(s). The LISN provide 50 Ohm/50uH of coupling impedance for the measuring instrument.

Interconnecting cables that hang closer than 40 cm to the ground plane shall be folded back and forth in the center forming a bundle 30 to 40 cm long.

I/O cables that are not connected to a peripheral shall be bundled in the center. The end of the cable may be terminated, if required, using the correct terminating impedance. The overall length shall not exceed 1 m.

LISN at least 80 cm from the nearest part of EUT chassis.

The bandwidth of EMI test receiver is set at 9kHz, and the test frequency band is from 0.15MHz to 30MHz.

### 5.4 Deviation From Test Standard

No deviation

### 5.5 Test Data

Please refer to the Attachment A.



## 6 Conducted Emissions (Wired Network Port)

### 6.1 Test Standard and Limit

#### 6.1.1 Test Standard

**ETSI EN 301 489-1 Clause 8.7**  
**ETSI EN 301 489-3 & ETSI EN 301 489-17**  
**EN 55032:2015+A11:2020+A1:2020**

#### 6.1.2 Test Limit

**Table A.11 – Requirements for asymmetric mode conducted emissions from Class A equipment**

Applicable to					
1. wired network ports (3.1.32)					
2. optical fibre ports (3.1.25) with metallic shield or tension members					
3. antenna ports (3.1.3)					
Table clause	Frequency range MHz	Coupling device (see Table A.8)	Detector type / bandwidth	Class A voltage limits dB(µV)	Class A current limits dB(µA)
A11.1	0,15 to 0,5	AAN	Quasi Peak / 9 kHz	97 to 87	n/a
	0,5 to 30			87	
	0,15 to 0,5	AAN	Average / 9 kHz	84 to 74	
	0,5 to 30			74	
A11.2	0,15 to 0,5	CVP and current probe	Quasi Peak / 9 kHz	97 to 87	53 to 43
	0,5 to 30			87	43
	0,15 to 0,5	CVP and current probe	Average / 9 kHz	84 to 74	40 to 30
	0,5 to 30			74	30
A11.3	0,15 to 0,5	Current Probe	Quasi Peak / 9 kHz	n/a	53 to 43
	0,5 to 30				43
	0,15 to 0,5	Current Probe	Average / 9 kHz		40 to 30
	0,5 to 30				30
The choice of coupling device and measurement procedure is defined in Annex C.					
AC mains ports that also have the function of a wired network port shall meet the limits given in Table A.9.					
The measurement shall cover the entire frequency range.					
The application of the voltage and/or current limits is dependent on the measurement procedure used. Refer to Table C.1 for applicability.					
Testing is required at only one EUT supply voltage and frequency.					
Applicable to ports listed above and intended to connect to cables longer than 3 m.					



**Table A.12 – Requirements for asymmetric mode conducted emissions from Class B equipment**

Applicable to					
1. wired network ports (3.1.32) 2. optical fibre ports (3.1.25) with metallic shield or tension members 3. broadcast receiver tuner ports (3.1.8) 4. antenna ports (3.1.3)					
Table clause	Frequency range MHz	Coupling device (see Table A.8)	Detector type / bandwidth	Class B voltage limits dB(μV)	Class B current limits dB(μA)
A12.1	0,15 to 0,5	AAN	Quasi Peak / 9 kHz	84 to 74	n/a
	0,5 to 30			74	
	0,15 to 0,5	AAN	Average / 9 kHz	74 to 64	
	0,5 to 30			64	
A12.2	0,15 to 0,5	CVP and current probe	Quasi Peak / 9 kHz	84 to 74	40 to 30
	0,5 to 30			74	30
	0,15 to 0,5	CVP and current probe	Average / 9 kHz	74 to 64	30 to 20
	0,5 to 30			64	20
A12.3	0,15 to 0,5	Current Probe	Quasi Peak / 9 kHz	n/a	40 to 30
	0,5 to 30				30
	0,15 to 0,5	Current Probe	Average / 9 kHz		30 to 20
	0,5 to 30				20

The choice of coupling device and measurement procedure is defined in Annex C.

Screened ports including TV broadcast receiver tuner ports are measured with a common-mode impedance of 150 Ω. This is typically accomplished with the screen terminated by 150 Ω to earth.

AC mains ports that also have the function of a wired network port shall meet the limits given in Table A.10.

The measurement shall cover the entire frequency range.

The application of the voltage and/or current limits is dependent on the measurement procedure used. Refer to Table C.1 for applicability.

Measurement is required at only one EUT supply voltage and frequency.

Applicable to ports listed above and intended to connect to cables longer than 3 m.

## 6.2 Test Setup

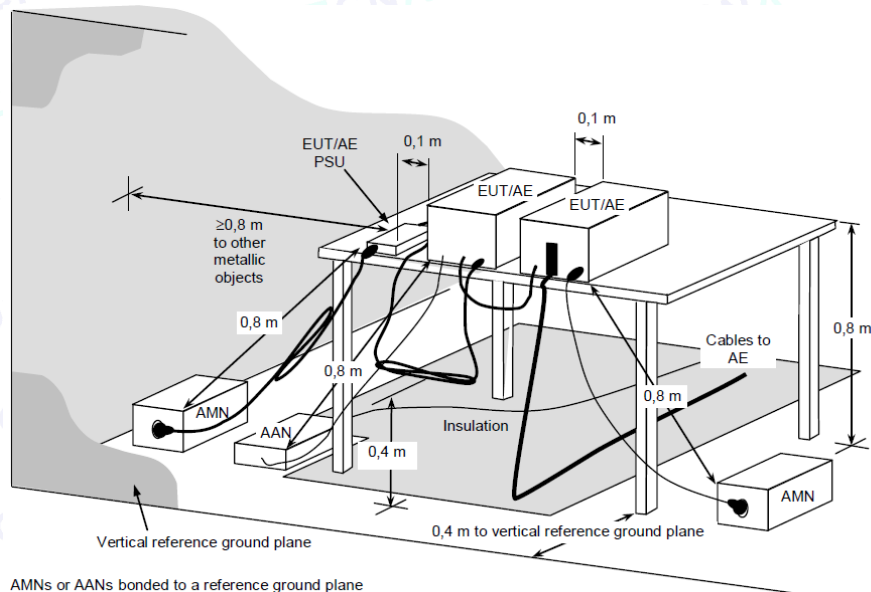

**6.3 Test Procedure**

Detailed test procedure was following clause C.4.1 of EN 55032.

Frequency range 150kHz–30MHz was checked and EMI receiver measurement bandwidth was set to 9 kHz.

Data Port	Measurement type	Coupling device	No. of Pairs
Balanced Unscreened	Voltage	AAN	≤ 4
Balanced Unscreened	Voltage and Current	CVP & Current probe	>4 or unable to AAN
Screened or Coaxial	Voltage	AAN	N/A
Screened or Coaxial	Voltage or Current	Current probe / "150Ω to 50Ω adaptor" / high impedance probe	N/A
Unbalanced cables	Voltage and Current	CVP & Current probe	N/A

**6.4 Deviation From Test Standard**

No deviation

**6.5 Test Data**

N/A.



## 7 Radiated Emission Test

### 7.1 Test Standard and Limit

#### 7.1.1 Test Standard

**ETSI EN 301 489-1 Clause 8.2**  
**ETSI EN 301 489-3 & ETSI EN 301 489-17**  
**EN 55032:2015+A11:2020+A1:2020**

#### 7.1.2 Test Limit

Radiated Disturbance Test Limit

FREQUENCY (MHz)	Class A (at 3m)	Class B (at 3m)
	dBuV/m	dBuV/m
30 – 230	50	40
230 – 1000	57	47

Notes:

- (1) The limit for radiated test was performed according to as following: EN 55032
- (2) The tighter limit applies at the band edges.
- (3) Emission level (dBuV/m)=20log Emission level (uV/m).

Limits of Radiated Emission Measurement (Above 1000MHz)

FREQUENCY (MHz)	Class A (dBuV/m) (at 3m)		Class B (dBuV/m) (at 3m)	
	PEAK	AVERAGE	PEAK	AVERAGE
1000-3000	80	60	74	54
3000-6000	80	60	74	54

Notes:

- (1) The lower limit applies at the transition frequency.

Frequency Range of Radiated Measurement

Highest frequency generated or Upper frequency of measurement used in the device or on which the device operates or tunes (MHz)	Range (MHz)
Below 108	1000
108 – 500	2000
500 – 1000	5000
Above 1000	5th harmonic of the highest frequency or 6 GHz, whichever is lower



7.2 Test Setup

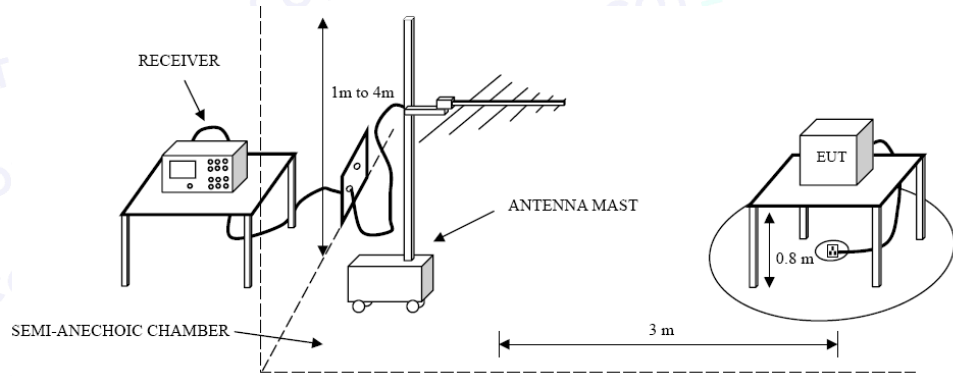

Below-1G

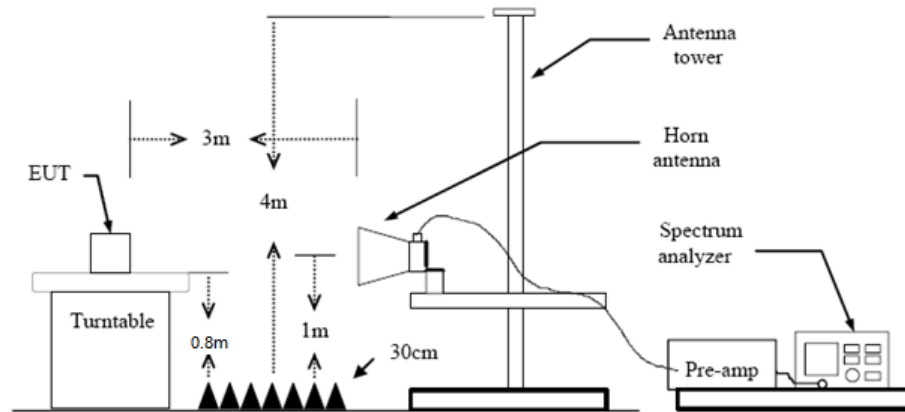

Above 1G

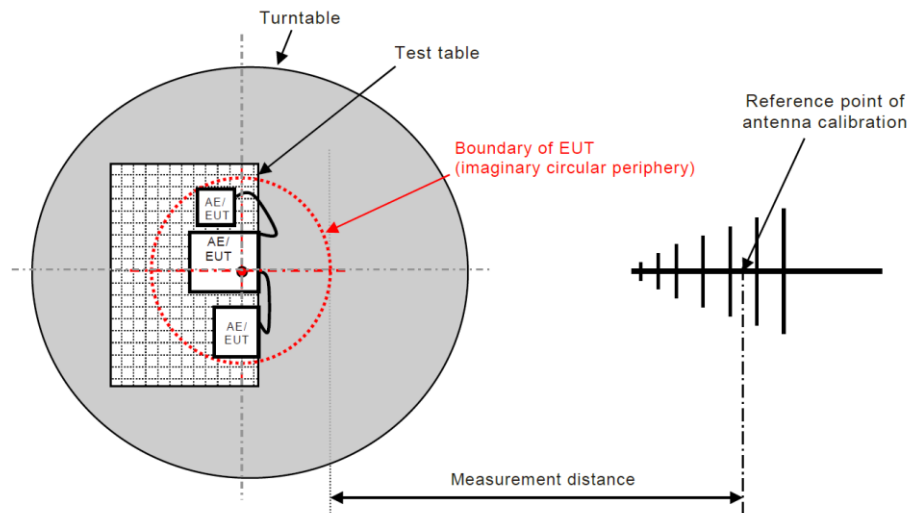

Figure C.1 – Measurement distance



### 7.3 Test Procedure

The EUT was placed on the top of a rotating table 0.8 meters above the ground at a 3m. The table was rotated 360 degrees to determine the position of the highest radiation.

The EUT and local AE shall be arranged in the most compact practical arrangement within the test volume, while respecting typical spacing and the requirements defined in Annex D. The central point of the arrangement shall be positioned at the centre of the turntable. The measurement distance is the shortest horizontal distance between an imaginary circular periphery just encompassing this arrangement and the calibration point of the antenna. See Figure C.1 and Figure C.2.

The height of the equipment or of the substitution antenna shall be 0.8 m; the height of the test antenna shall vary between 1 m to 4 m. Both horizontal and vertical polarizations of the antenna are set to make the measurement.

The initial step in collecting radiated emission data is a spectrum Quasi Peak detector mode scanning the measurement frequency range.

If the Peak Mode measured value compliance with and lower than Quasi Peak Mode Limit, the EUT shall be deemed to meet QP Limits and then no additional QP Mode measurement performed.

### 7.4 Deviation From Test Standard

No deviation

### 7.5 Test Data

Please refer to the Attachment B.



## 8 Harmonic Current Emission Test

### 8.1 Test Standard and Limit

#### 8.1.1 Test Standard

ETSI EN 301 489-1 Clause 8.5  
ETSI EN 301 489-3 & ETSI EN 301 489-17  
EN IEC 61000-3-2:2019+A2:2024

#### 8.1.2 Test Limit

Limits for Class A equipment				Limits for Class D equipment		
Odd Harmonics		Even Harmonics		Harmonic Order (n)	Maximum Permissible Harmonic Current per watt (mA/W)	Maximum Permissible Harmonic Current (A)
Harmonic Order (n)	Maximum permissible harmonic Current (A)	Harmonic Order (n)	Maximum permissible harmonic Current (A)			
3	2.30	2	1.08	3	3.4	2.30
5	1.14	4	0.43	5	1.9	1.14
7	0.77	6	0.30	7	1.0	0.77
9	0.40	8 ≤ n ≤ 40	0.23X8/n	9	0.5	0.40
11	0.33			11	0.35	0.33
13	0.21			15 ≤ n ≤ 39 (odd harmonics only)	15 ≤ n ≤ 39	3.85/n
15 ≤ n ≤ 39	0.15X15/n					

### 8.2 Test Setup

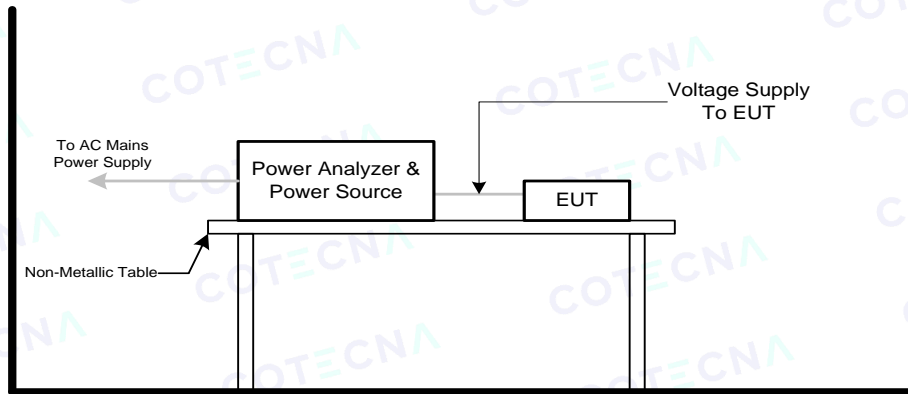

### 8.3 Test Procedure

The EUT was placed on the top of a wooden table 0.8 meters above the ground and operated to produce the maximum harmonic components under normal operating conditions.

The classification of EUT is according to section 5 of EN 61000-3-2. The EUT is classified as follows:

**Class A:** Balanced three-phase equipment, Household appliances excluding equipment as Class D, Tools excluding portable tools, Dimmers for incandescent lamps, audio equipment, equipment not specified in one of the three other classes.

**Class D:** Equipment having a specified power less than or equal to 600 W of the following types: Personal computers and personal computer monitors and television receivers.



8.4 Deviation From Test Standard

No deviation

8.5 Test Data

N/A.



## 9 Voltage Fluctuation and Flicker Test

### 9.1 Test Standard and Limit

#### 9.1.1 Test Standard

**ETSI EN 301 489-1 Clause 8.6**  
**ETSI EN 301 489-3 & ETSI EN 301 489-17**  
**EN 61000-3-3:2013+A2:2021**

#### 9.1.2 Test Limit

Flicker Test Limit

Test Items	Limits
Pst	1.0
dc	3.3%
dmax	4.0%
dt	Not exceed 3.3% for 500ms

### 9.2 Test Setup

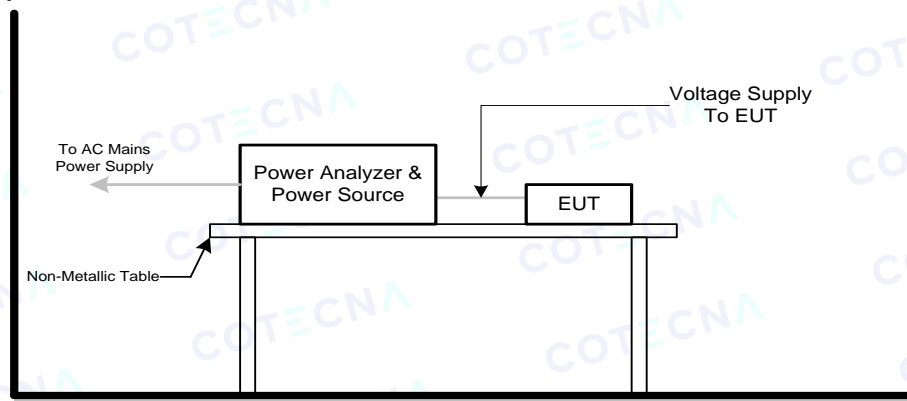

### 9.3 Test Procedure

Fluctuation and Flickers Test:

Tests was performed according to the Test Conditions/Assessment of Voltage Fluctuations specified in Clause 5.0/6.0 of IEC555-3 and/or Clause 6.0/4.0 of IEC/EN 61000-3-3 depend on which standard adopted for compliance measurement.

All types of harmonic current and/or voltage fluctuation in this report are assessed by direct measurement using flicker-meter.

For the actual test configuration, please refer to the related Item–Block Diagram of system tested.

### 9.4 Deviation From Test Standard

No deviation

### 9.5 Test Data

N/A.



## 10 Electrostatic Discharge Immunity Test

### 10.1 Test Standard and Limit

#### 10.1.1 Test Standard

**ETSI EN 301 489-1 Clause 9.3**  
**ETSI EN 301 489-3 & ETSI EN 301 489-17**  
**EN 61000-4-2:2009**

#### 10.1.2 Test Level

<b>Discharge Impedance:</b>	330 ohm/ 150pF
<b>Discharge Voltage:</b>	Air Discharge: 2kV/4kV/8kV(Direct) Contact Discharge: 2kV/4kV (Direct /Indirect)
<b>Polarity:</b>	Positive& Negative
<b>Discharge Mode:</b>	Single Discharge
<b>Discharge Period:</b>	1 second minimum

### 10.2 Test Setup

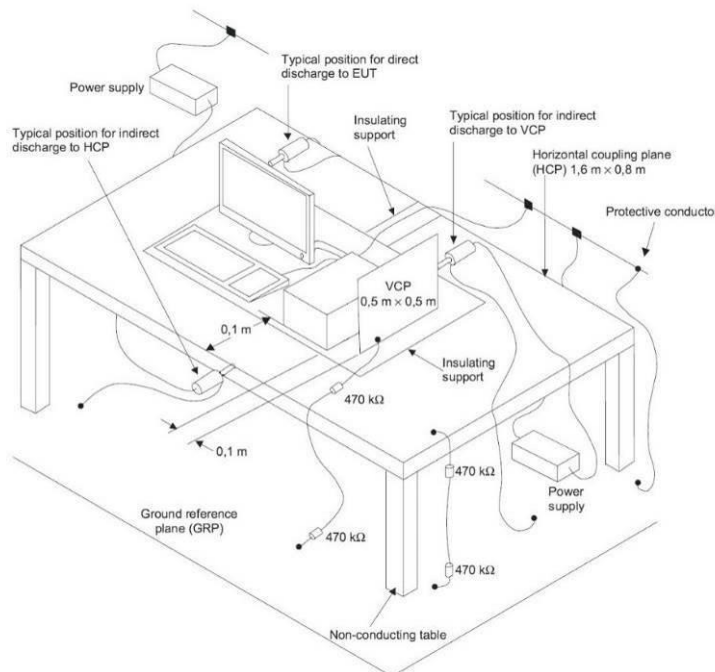

### 10.2 Test Procedure

The test method shall be in accordance with CENELEC EN 61000-4-2 [2], clauses 6, 7 and 8.

For radio equipment and ancillary equipment the following requirements and evaluation of test results shall apply.

The test severity level for contact discharge shall be  $\pm 4$  kV and for air discharge  $\pm 8$  kV. All other details, including intermediate test levels, are contained within CENELEC EN 61000-4-2 [2], clause 5.

Electrostatic discharges shall be applied to all exposed surfaces of the EUT except where the user documentation specifically indicates a requirement for appropriate protective measures (as specified in CENELEC EN 61000-4-2 [2], clauses 8.3.2 and 8.3.3).



10.3 Deviation From Test Standard

No deviation

10.4 Test Data

Please refer to the Attachment C.



# 11 Radiated Electromagnetic Field Immunity test

## 11.1 Test Standard and Limit

### 11.1.1 Test Standard

**ETSI EN 301 489-1 Clause 9.2**  
**ETSI EN 301 489-3 & ETSI EN 301 489-17**  
**EN IEC 61000-4-3:2020**

### 11.1.2 Test Level

Test Level for Radiated Electromagnetic Field Immunity Test

Port	Test Specification
Enclosure Port	80-6000MHz 3 V/m 80 % AM (1kHz)

## 11.2 Test Setup

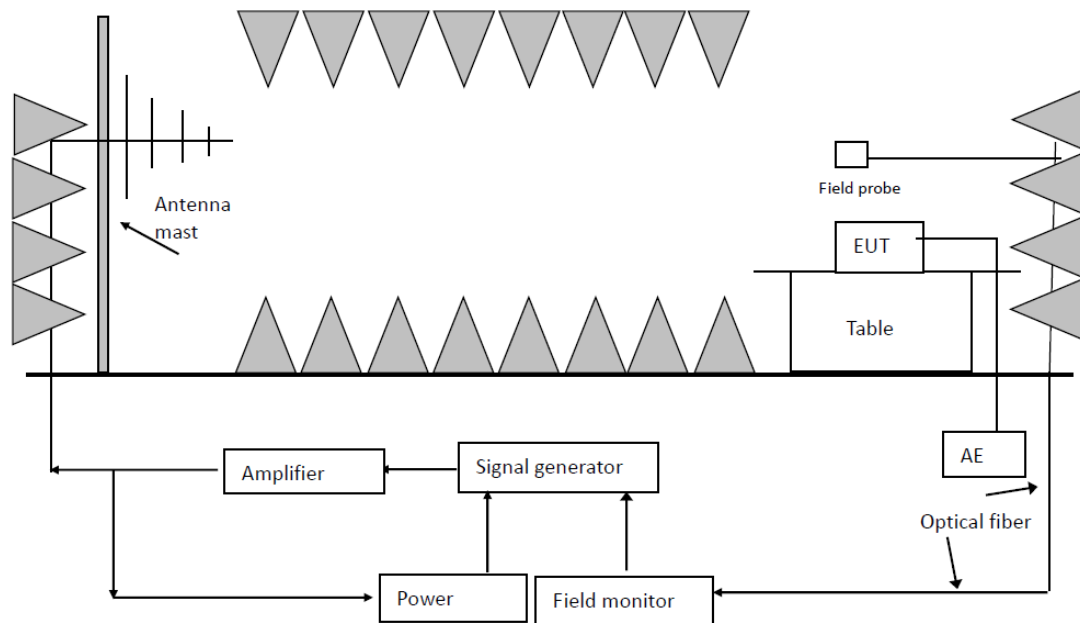

### 11.3 Test Procedure

The test method shall be in accordance with CENELEC EN 61000-4-3 [3], clauses 6, 7 and 8.

The following requirements and evaluation of test results shall apply:

- the test level shall be 3 V/m (measured unmodulated). The test signal shall be amplitude modulated to a depth of 80 % by a sinusoidal audio signal of 1 000 Hz.

If the wanted signal is modulated at 1 000 Hz, then an audio signal of 400 Hz shall be used;

- the test shall be performed over the frequency range 80 MHz to 6 000 MHz with the exception of the exclusion band for transmitters, receivers and duplex transceivers (see clause 4.3), as appropriate;
- for receivers and transmitters the stepped frequency increments shall be 1 % frequency increment of the momentary used frequency;
- the dwell time of the test phenomena at each frequency shall not be less than the time necessary for the EUT to be exercised and to be able to respond;

NOTE: Dwell time is product dependent.

- the frequencies selected and used during the test shall be recorded.

All the scanning conditions are as following:

Condition of Test	Remark
Fielded Strength	3V/m
Radiated Signal	80%AM,1kHz Since Wave
Scanning Frequency	80-6000MHz

Note:  
 The exclusion band for immunity testing of equipment operating in the 2,4 GHz band shall be:  
 • lower limit of exclusion band = lowest allocated band edge frequency -120 MHz, i.e. 2 280 MHz;  
 • upper limit of exclusion band = highest allocated band edge frequency +120 MHz, i.e. 2 603,5MHz.  
 The exclusion band for immunity testing of equipment operating in the 5 GHz Wi-Fi band shall be:  
 • lower limit of exclusion band = lowest allocated band edge frequency -270 MHz, i.e. 4 880 MHz;  
 • upper limit of exclusion band = highest allocated band edge frequency +270 MHz, i.e. 5 995 MHz.

### 11.4 Deviation From Test Standard

No deviation

### 11.5 Test Data

Please refer to the Attachment D.



## 12 Electrical Fast Transient/Burst Test

### 12.1 Test Standard and Limit

#### 12.1.1 Test Standard

**ETSI EN 301 489-1 Clause 9.4**  
**ETSI EN 301 489-3 & ETSI EN 301 489-17**  
**EN 61000-4-4:2012**

#### 12.1.2 Test Level

Test Level for Electrical Fast Transient Test

	On Switching Adapter Lines	On I/O (Input/Output) Signal data and control lines
<b>Test Voltage:</b>	1 KV	0.5 KV
<b>Polarity:</b>	Positive & Negative	
<b>Impulse Wave Shape:</b>	5/50ns	
<b>Burst Duration:</b>	15ms	
<b>Burst Period:</b>	300ms	
<b>Test Duration:</b>	Not less than 1 min	

### 12.2 Test Setup

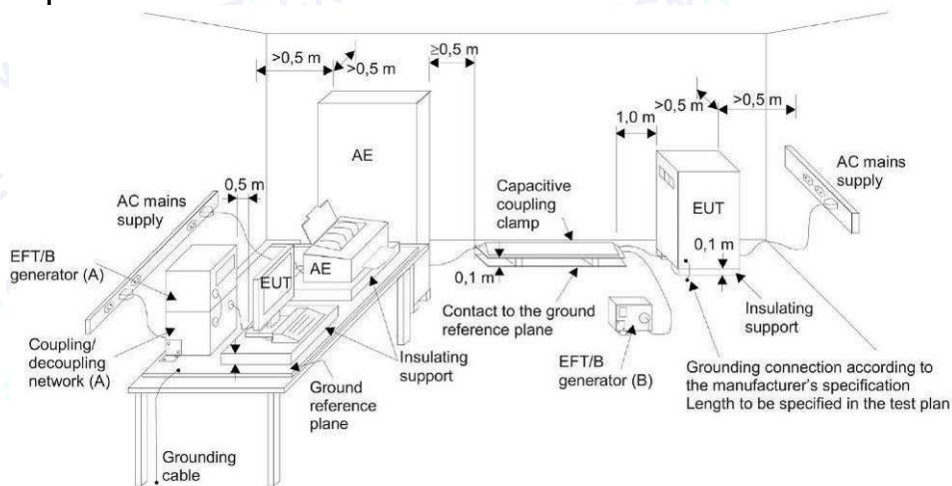

### 12.3 Test Procedure

The test method shall be in accordance with CENELEC EN 61000-4-4 [4], clauses 7 and 8.

The following requirements and evaluation of test results shall apply:

- the test level for signal ports, wired network ports (excluding xDSL), and control ports shall be 0,5 kV open circuit voltage at a repetition rate of 5 kHz as given in CENELEC EN 61000-4-4 [4], clause 5;
- the test level for xDSL wired network ports shall be 0,5 kV open circuit voltage at a repetition rate of 100 kHz as given in CENELEC EN 61000-4-4 [4], clause 5;
- the test level for DC power input ports shall be 0,5 kV open circuit voltage at a repetition rate of 5 kHz as given CENELEC EN 61000-4-4 [4], clause 5;
- the test level for AC mains power input ports shall be 1 kV open circuit voltage at a repetition rate of 5 kHz as given CENELEC EN 61000-4-4 [4], clause 5.



12.4 Deviation From Test Standard

No deviation

12.5 Test Data

Please refer to the Attachment E.



## 13 Surge Immunity Test

### 13.1 Test Standard and Limit

#### 13.1.1 Test Standard

ETSI EN 301 489-1 Clause 9.8  
ETSI EN 301 489-3 & ETSI EN 301 489-17  
EN 61000-4-5:2014+A1:2017

#### 13.1.2 Test Level

#### Test Level for Surge Immunity Test

<b>Basic Standard:</b>	<b>EN 61000-4-5</b>
<b>Test Requirement:</b>	Analogue/digital data ports: 1KV (see a)
	DC network power ports: 0.5KV
	AC mains power ports: 1KV(Line-Line), 2KV(Line-earth)
<b>T<sub>r</sub>/T<sub>h</sub></b>	1.2/50us, 10/700us
<b>Polarity:</b>	Positive/Negative
<b>Phase Angle:</b>	0/90/180/270
<b>Pulse Repetition Rate:</b>	1 time/min.(maximum)
<b>Number of Tests:</b>	5 positive and 5 negative at selected points
a: Port type: coaxial or shielded. Apply: shield to ground.	

### 13.2 Test Setup

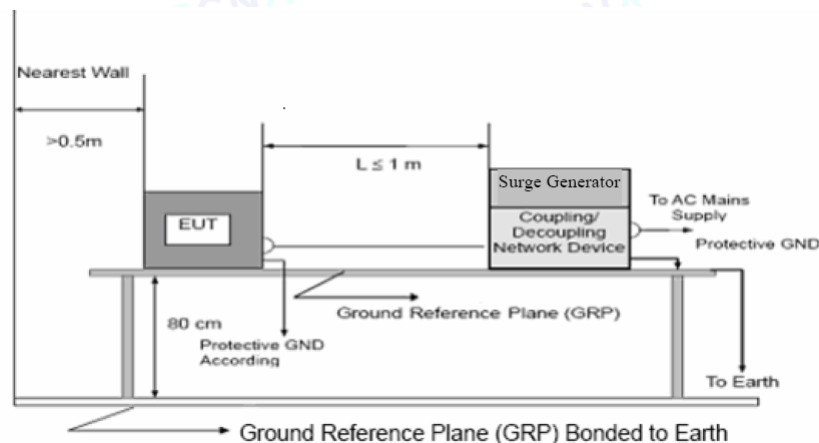

### 13.3 Test Procedure

- 1) Set the parameters of the CW generator and interference generator as shown in tables 4.2.9.2-1 and 4.2.9.2-2.
- 2) Set the power level of the UE according to tables 4.2.9.2-1 and 4.2.9.2-2 with a ±1 dB tolerance.
- 3) Measure the BER of DCH received from the UE at the SS.

Details of initial conditions for UEs supporting UTRA FDD can be found in ETSI TS 134 121-1 [1], clause 6.7.

### 13.4 Deviation From Test Standard

No deviation

### 13.5 Test Data

Please refer to the Attachment F.



## 14 RF Common Mode

### 14.1 Test Standard and Limit

#### 14.1.1 Test Standard

**ETSI EN 301 489-1 Clause 9.5**  
**ETSI EN 301 489-3 & ETSI EN 301 489-17**  
**EN IEC 61000-4-6:2023**

#### 14.1.2 Test Level

Test Level for RF Common Mode

Port	Test Specification
Input AC power port	0.15MHz~80MHz 3V(r.m.s.) (unmodulated)

### 14.2 Test Setup

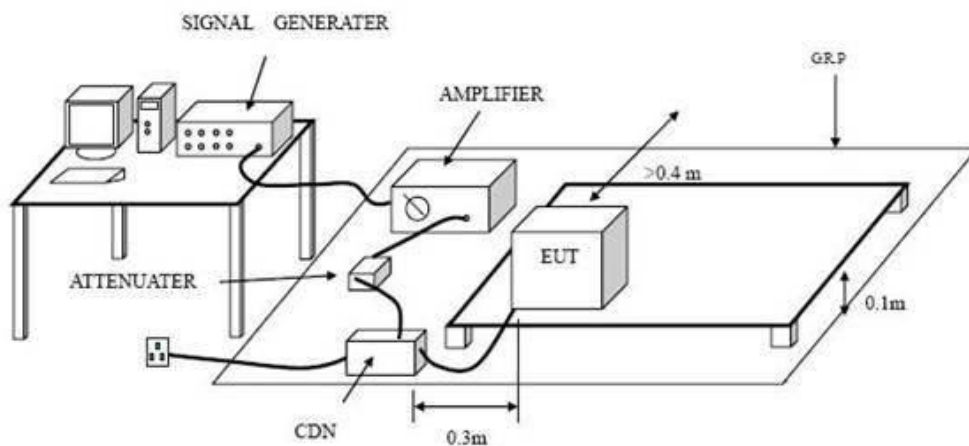

### 14.2 Test Procedure

The following requirements and evaluation of test results shall apply:

- the test level shall be severity level 2 as given in CENELEC EN 61000-4-6 [6], clause 5 corresponding to 3 V rms unmodulated. The test signal shall then be amplitude modulated to a depth of 80 % by a sinusoidal audio signal of 1 000 Hz. If the wanted signal is modulated at 1 000 Hz, then the test signal of 400 Hz shall be used;
- the test shall be performed over the frequency range 150 kHz to 80 MHz with the exception of an exclusion band for transmitters, and for receivers and duplex transceivers, (see clause 4.3);
- for receivers and transmitters the stepped frequency increments shall be 1 % frequency increment of the momentary frequency in the frequency range 150 kHz to 80 MHz;
- the injection method to be used shall be selected according to the basic standard CENELEC EN 61000-4-6 [6], clause 7;
- responses on receivers or receiver parts of transceivers occurring at discrete frequencies which are narrow band responses (spurious responses), are disregarded from the test (as specified in clause 4); the dwell time of the test phenomena at each frequency shall not be less than the time necessary for the EUT to be exercised and to be able to respond;
- the frequencies of the immunity test signal selected and used during the test shall be recorded.



14.3 Deviation From Test Standard

No deviation

14.4 Test Data

Please refer to the Attachment G.



## 15 Voltage Dips and Interruptions Immunity Test

### 15.1 Test Standard and Limit

#### 15.1.1 Test Standard

**ETSI EN 301 489-1 Clause 9.7**  
**ETSI EN 301 489-3 & ETSI EN 301 489-17**  
**EN IEC 61000-4-11:2020**

#### 15.1.2 Test Level

Test Level for Voltage Dips and Interruptions

<b>Basic Standard:</b>	<b>EN IEC 61000-4-11</b>
<b>Required Performance:</b>	B(For 100% Voltage Dips) B(For 100% Voltage Dips) C(For 30% Voltage Dips) C(For 100% Voltage Interruptions)
<b>Test Duration Time:</b>	Minimum three test events in sequence
<b>Interval Between Event:</b>	Minimum ten seconds
<b>Phase Angle:</b>	0°/45°/90°/135°/180°/225°/270°/315°/360°
<b>Test Cycle:</b>	3 times

### 15.2 Test Setup

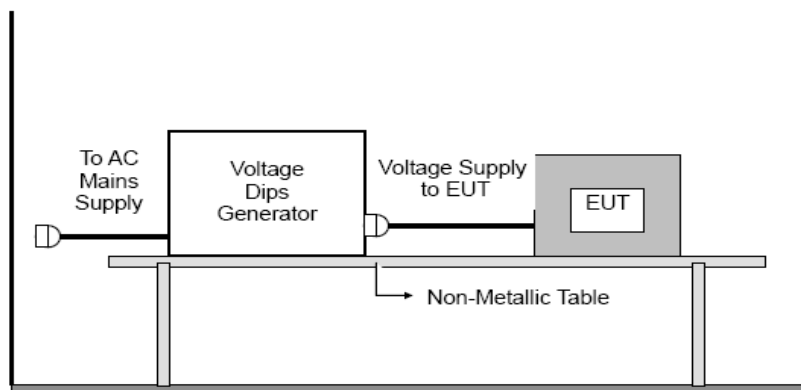

### 15.2 Test Procedure

The following requirements and evaluation of test results shall apply.  
The test method shall be in accordance with CENELEC EN 61000-4-11  
The test levels shall be:

- voltage dip: 0 % residual voltage for 0,5 cycle;
- voltage dip: 0 % residual voltage for 1 cycle;
- voltage dip: 70 % residual voltage for 25 cycles (at 50 Hz);
- voltage interruption: 0 % residual voltage for 250 cycles (at 50 Hz).

### 15.3 Deviation From Test Standard

No deviation

### 15.4 Test Data

Please refer to the Attachment H.



## 16 Photographs--Constructional Details

Photo 1 Appearance of EUT

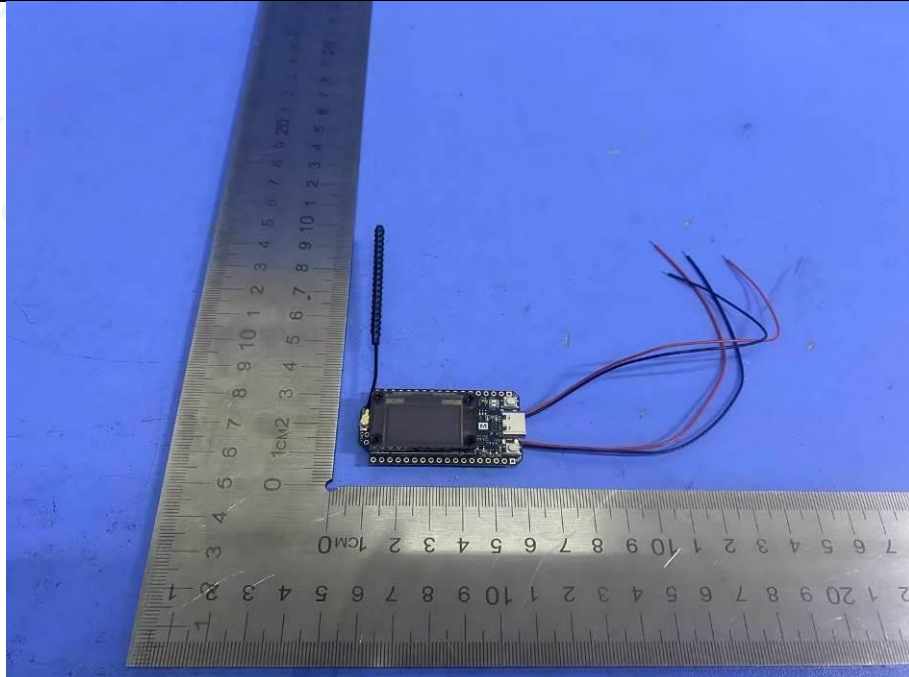

Photo 2 Appearance of EUT

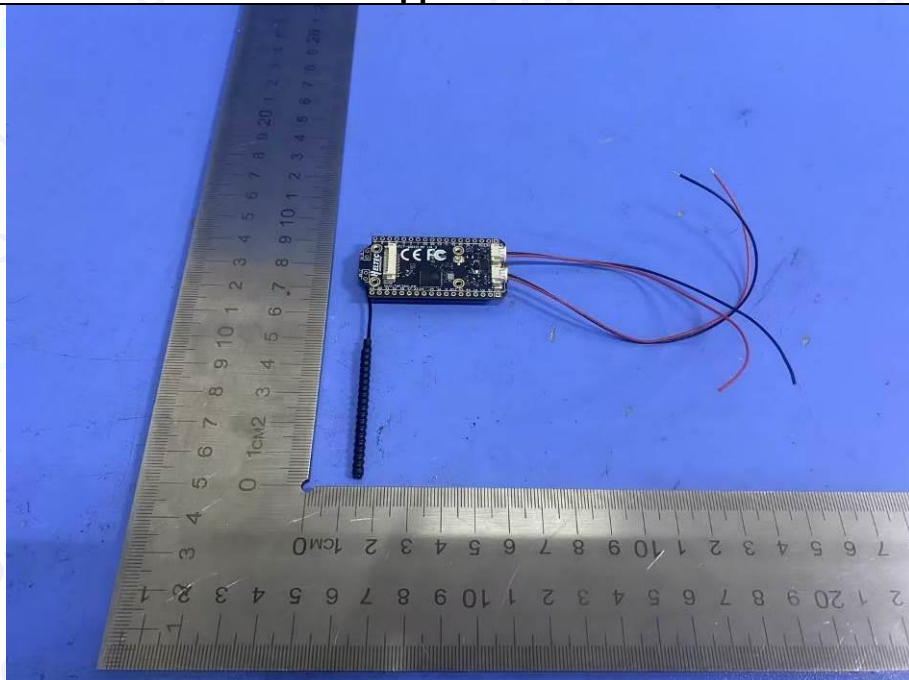

Photo 3 Appearance of EUT

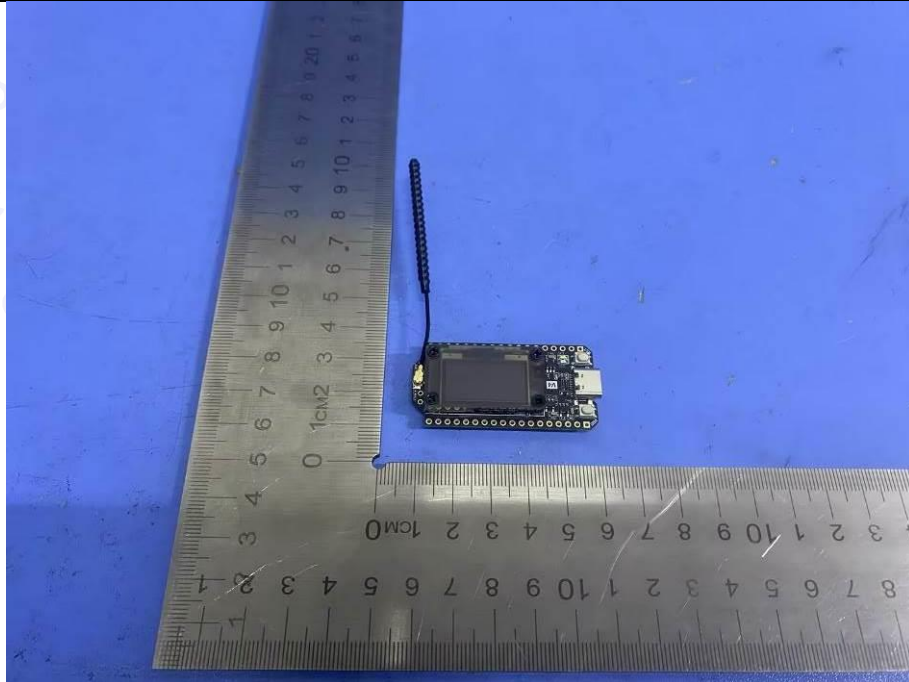

Photo 4 Appearance of EUT

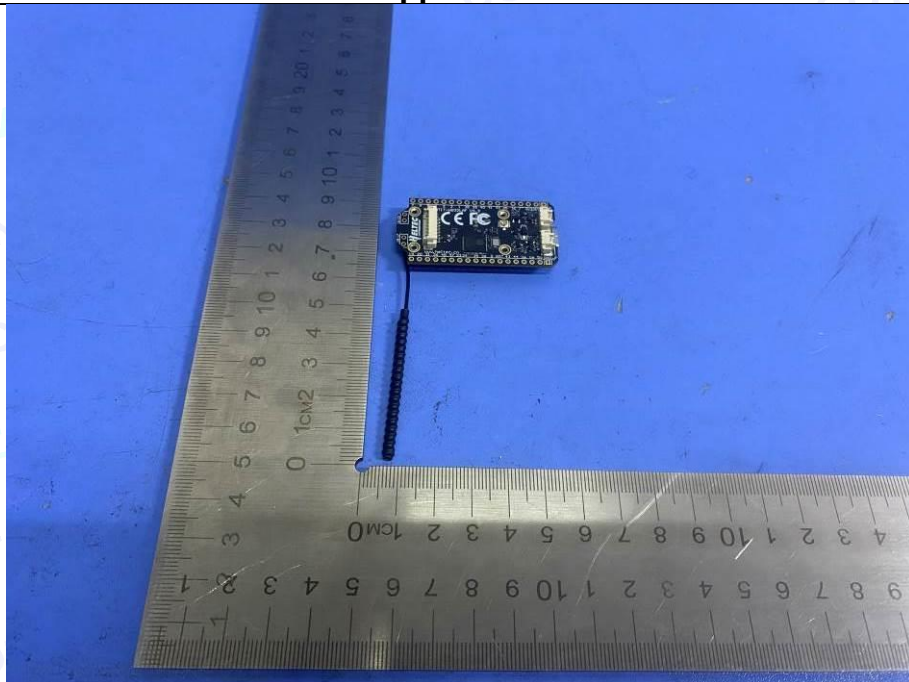

Photo 5 Appearance of EUT

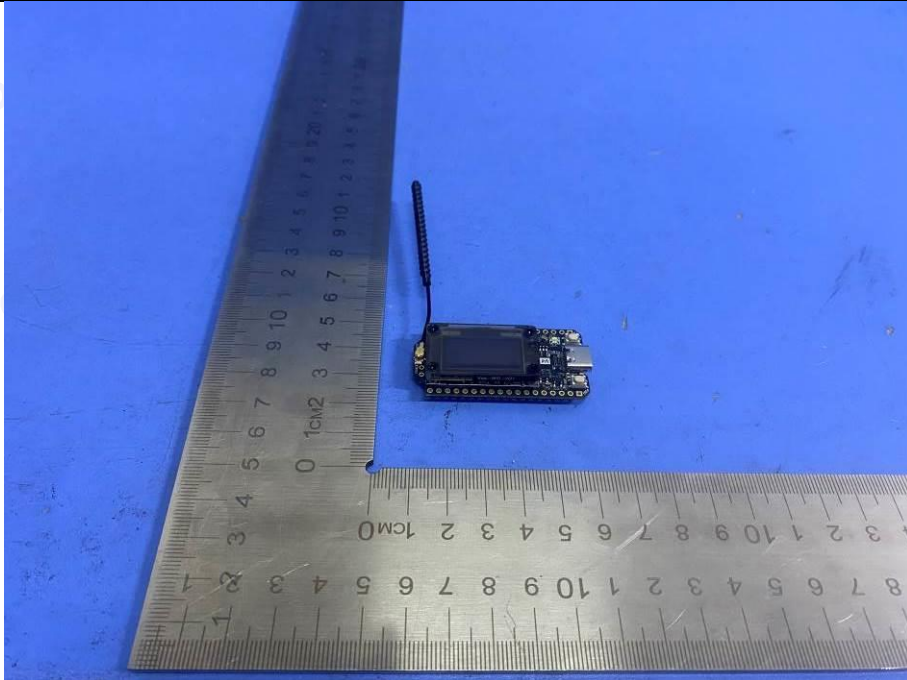

Photo 6 Appearance of EUT

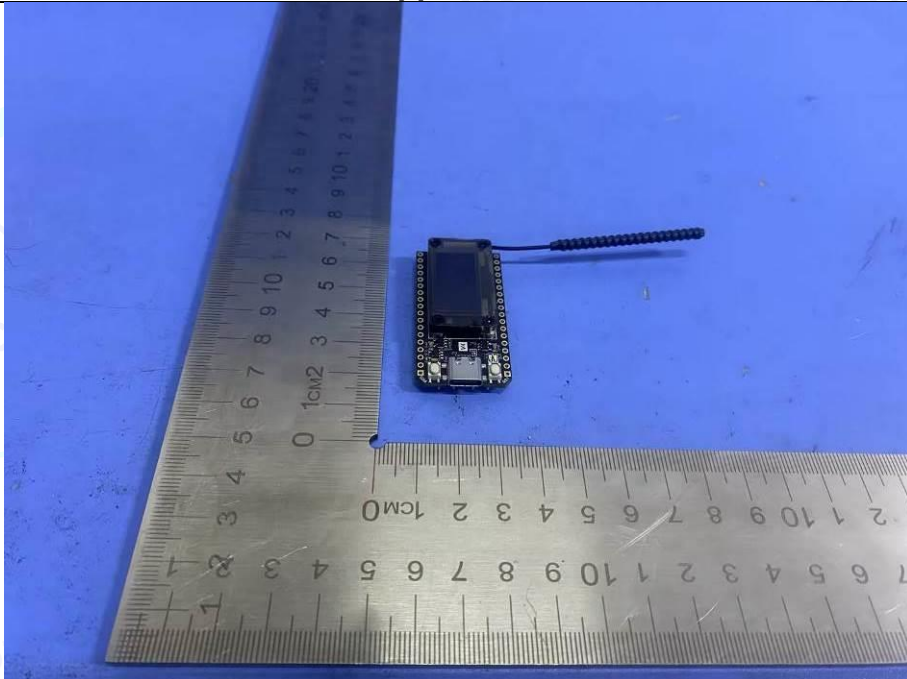

Photo 7 Appearance of EUT

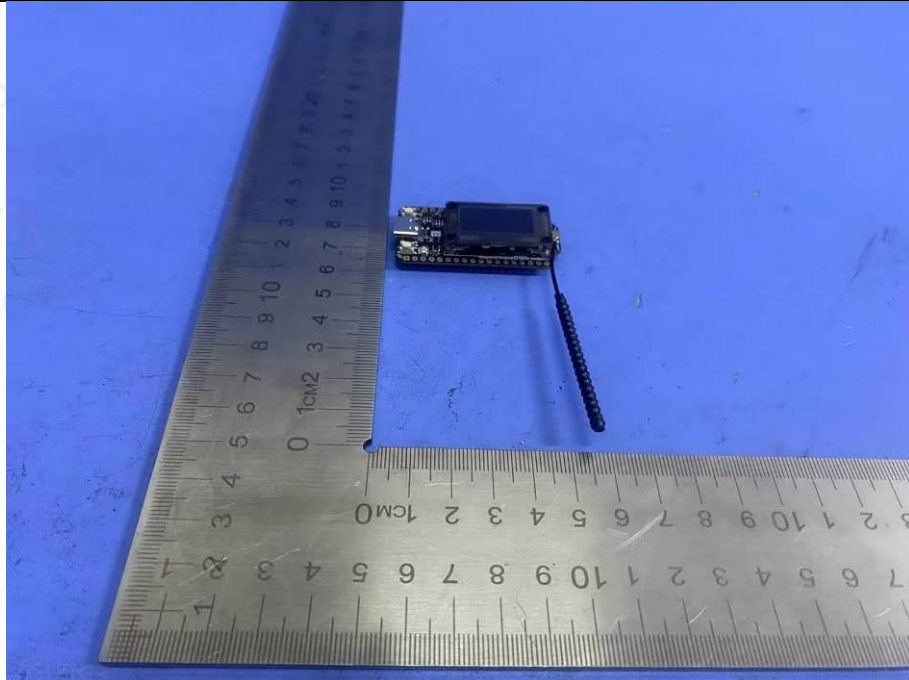

Photo 8 Appearance of EUT

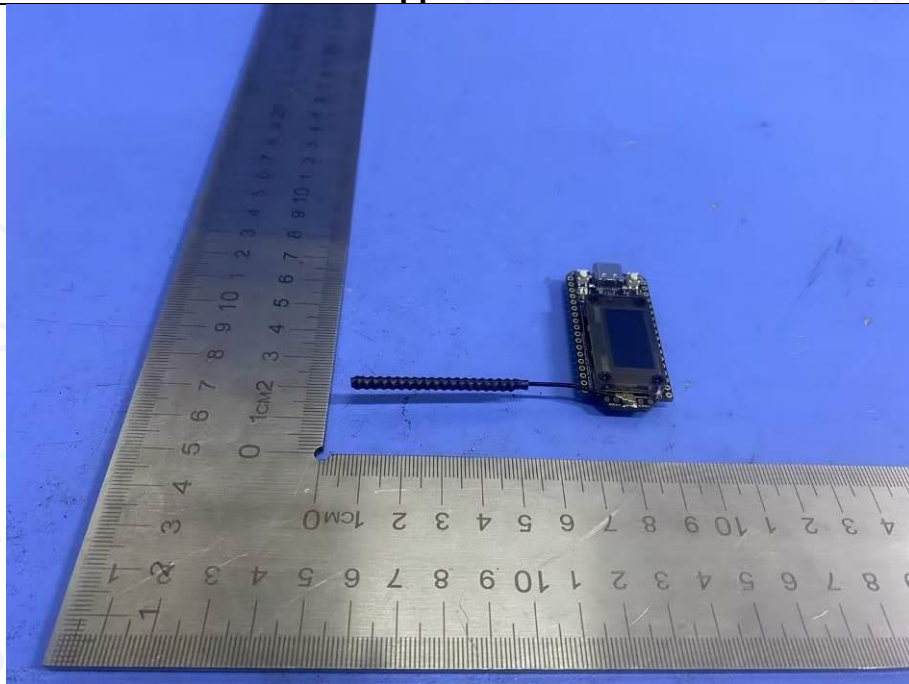

Photo 9 Appearance of EUT

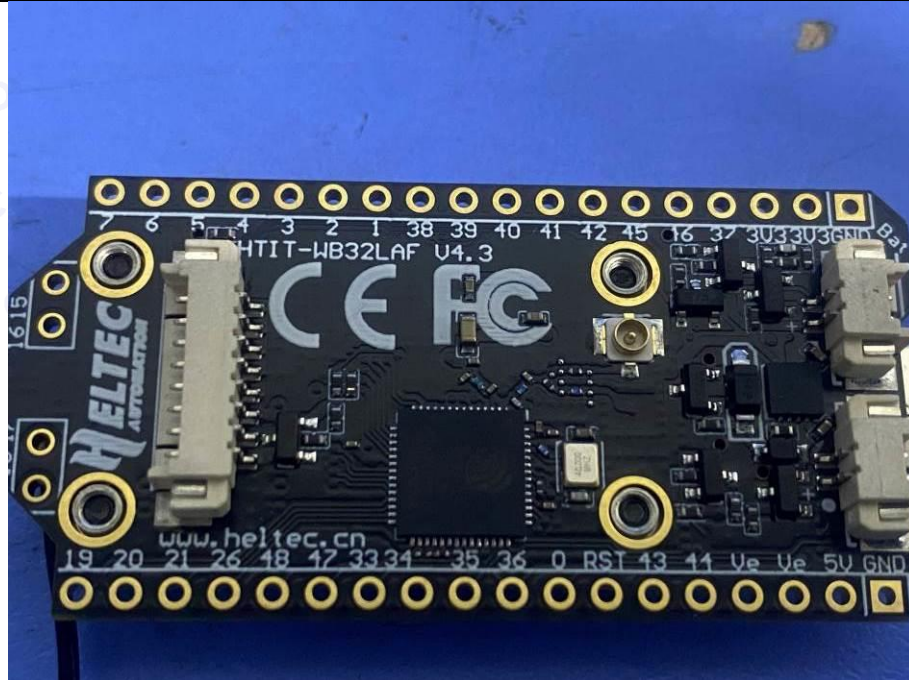

Photo 10 Internal of EUT

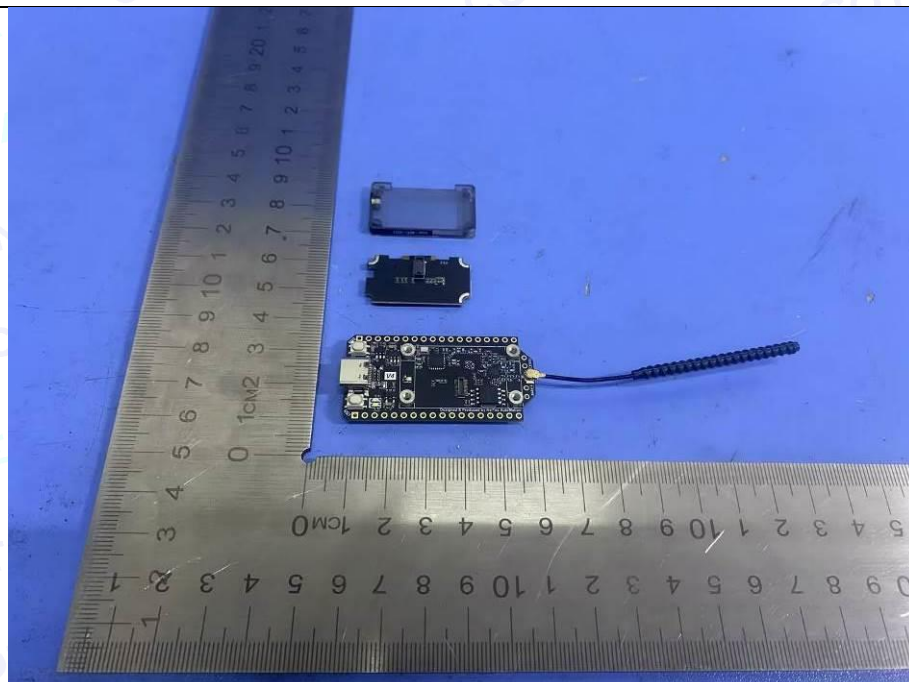

Photo 11 Internal of Antenna

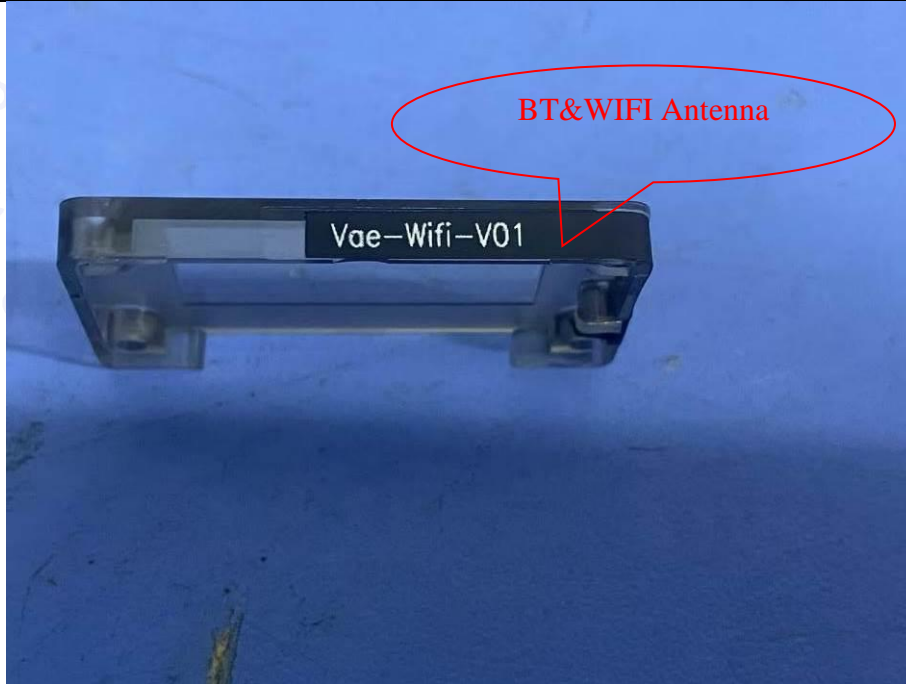

Photo 12 Internal of Antenna



Photo 13 Appearance of PCB

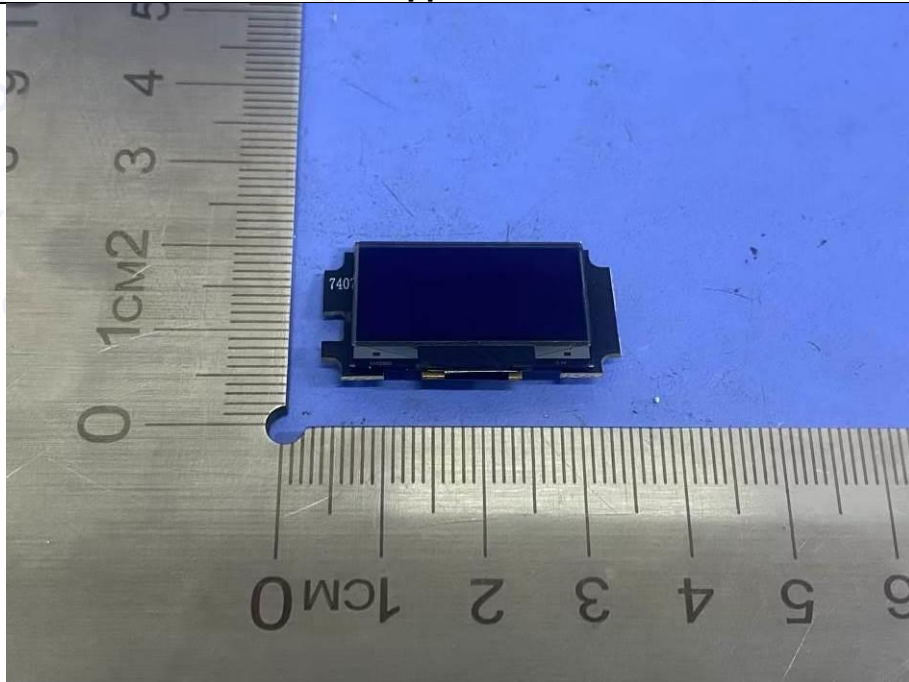

Photo 14 Appearance of PCB

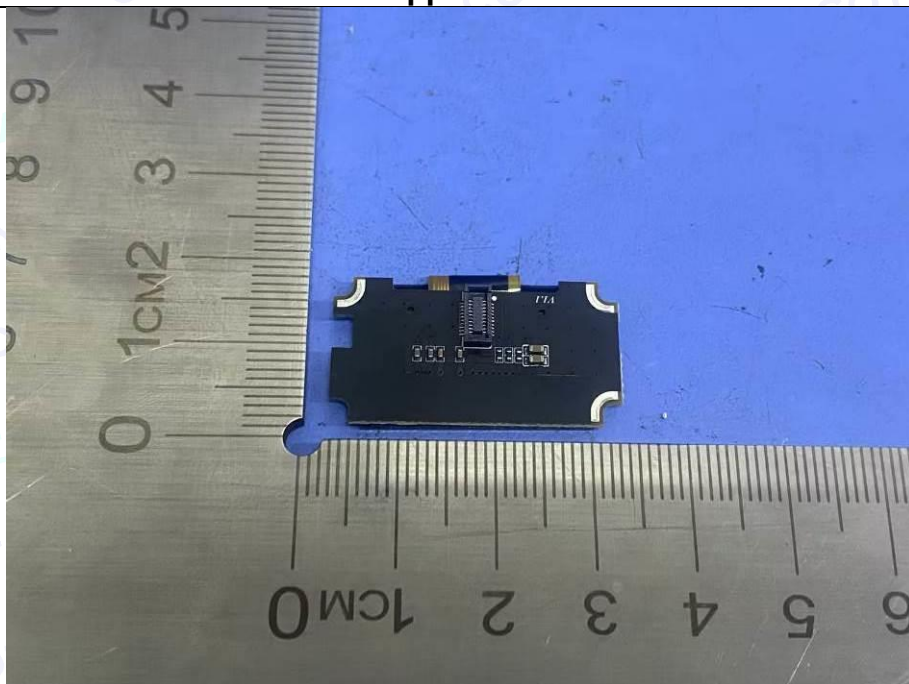

Photo 15 Appearance of PCB

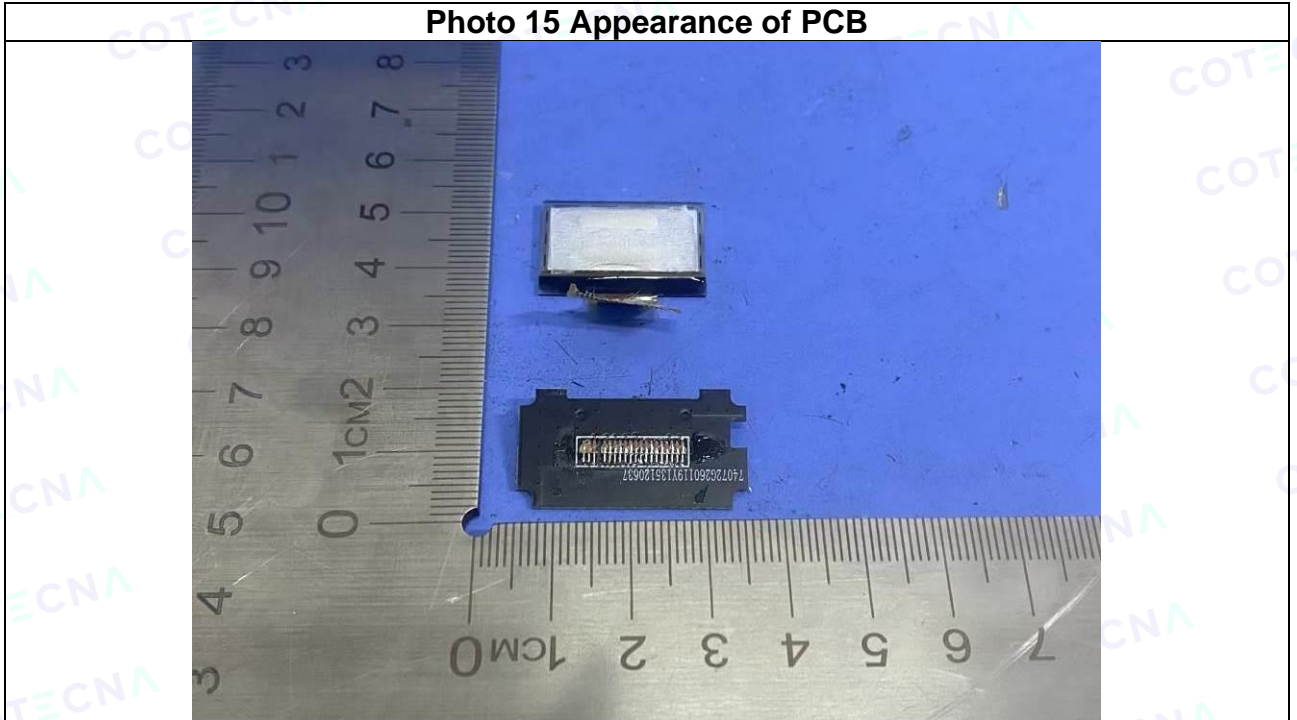

Photo 16 Appearance of PCB

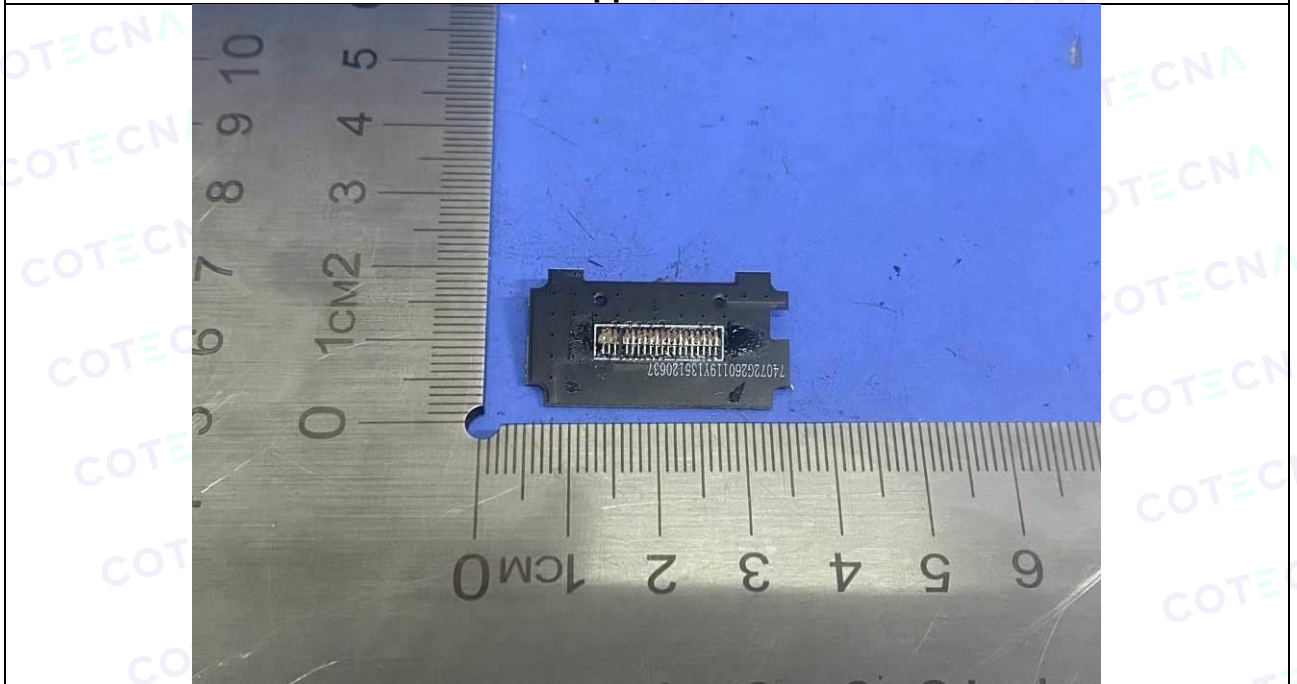

Photo 17 Appearance of PCB

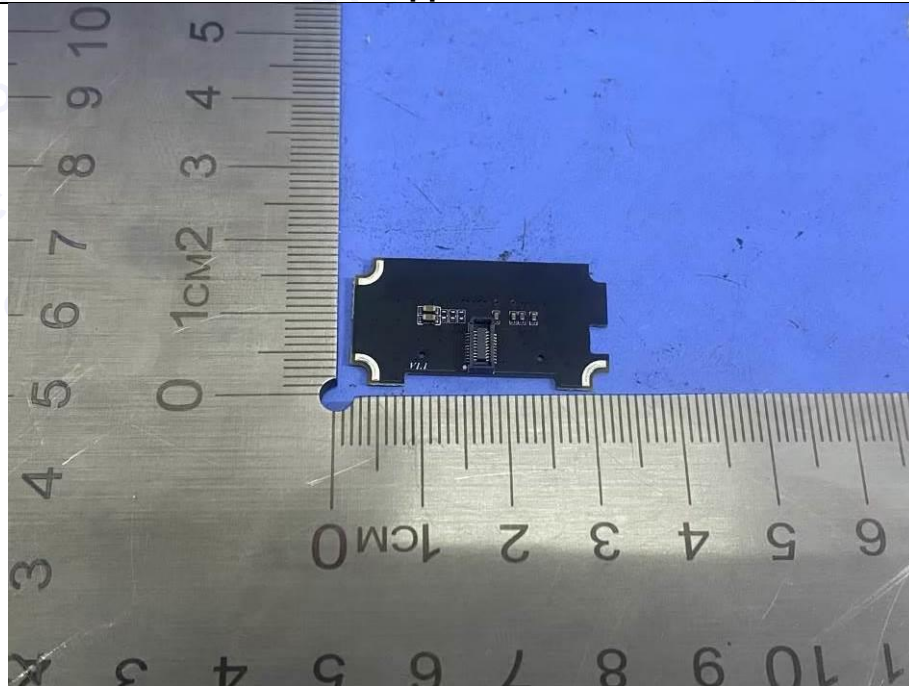

Photo 18 Appearance of PCB

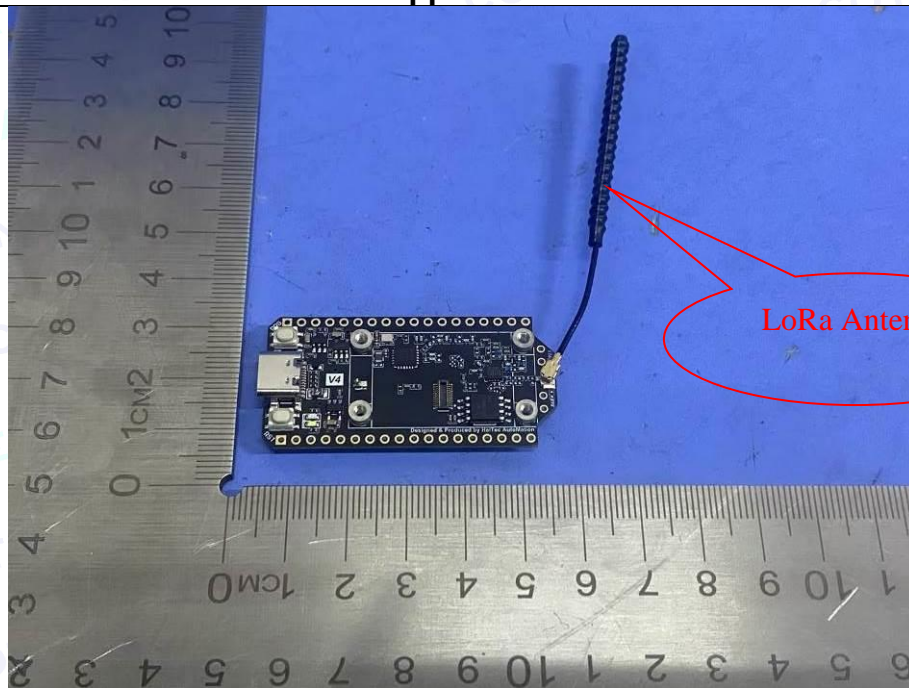

Photo 19 Appearance of PCB

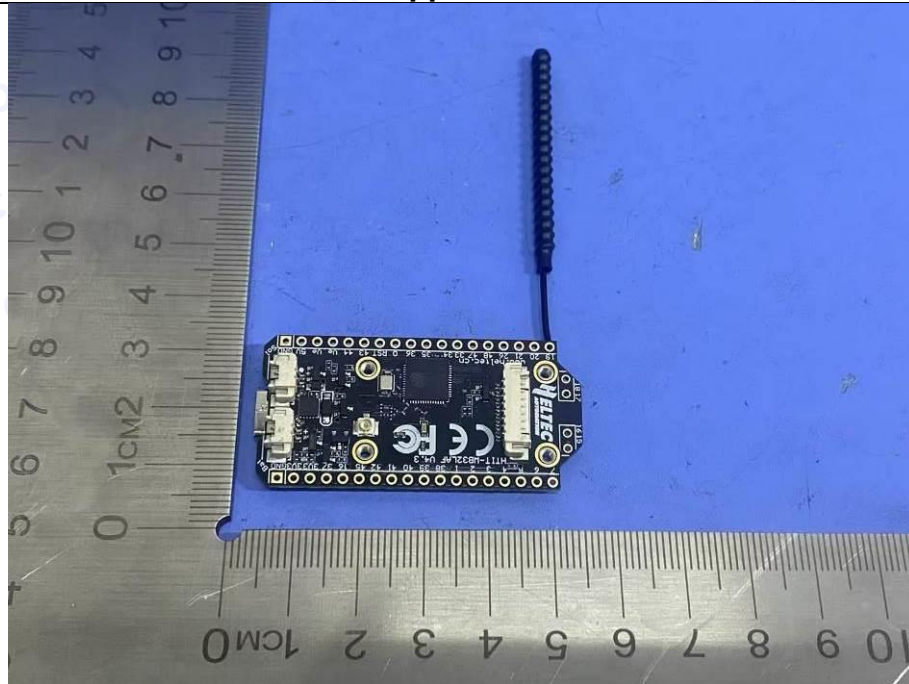
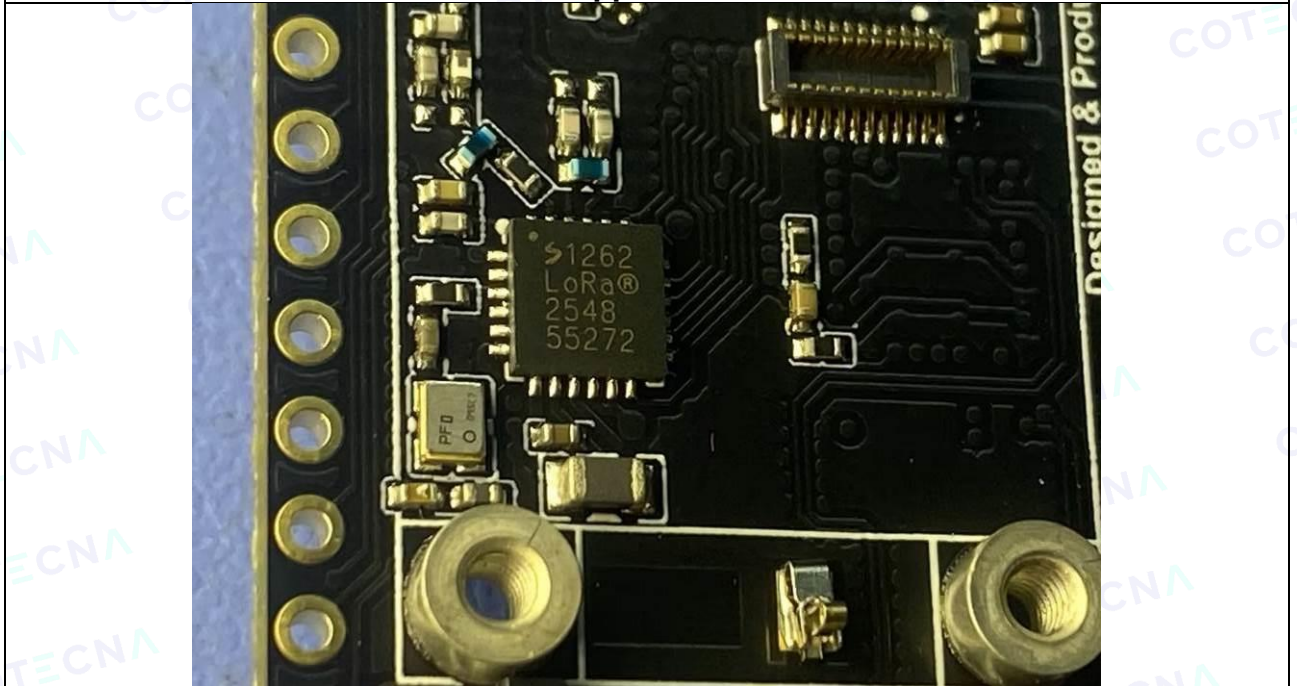

Photo 20 Appearance of PCB

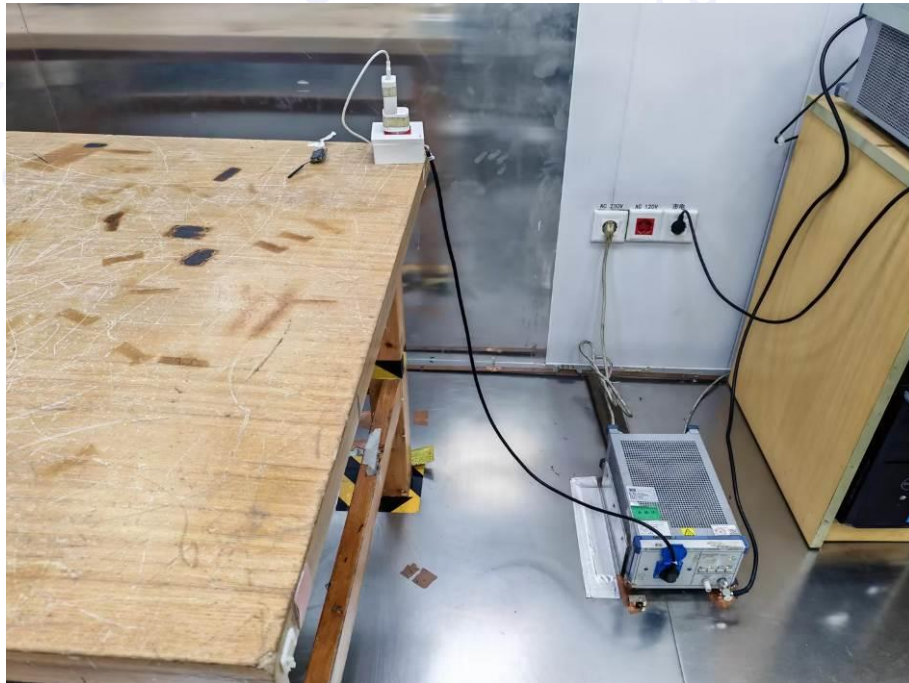

Photo 21 Appearance of PCB



## 17 Photographs--Test Setup

Conducted Emission Test Setup



Radiated Emission Test Setup-Below 1G

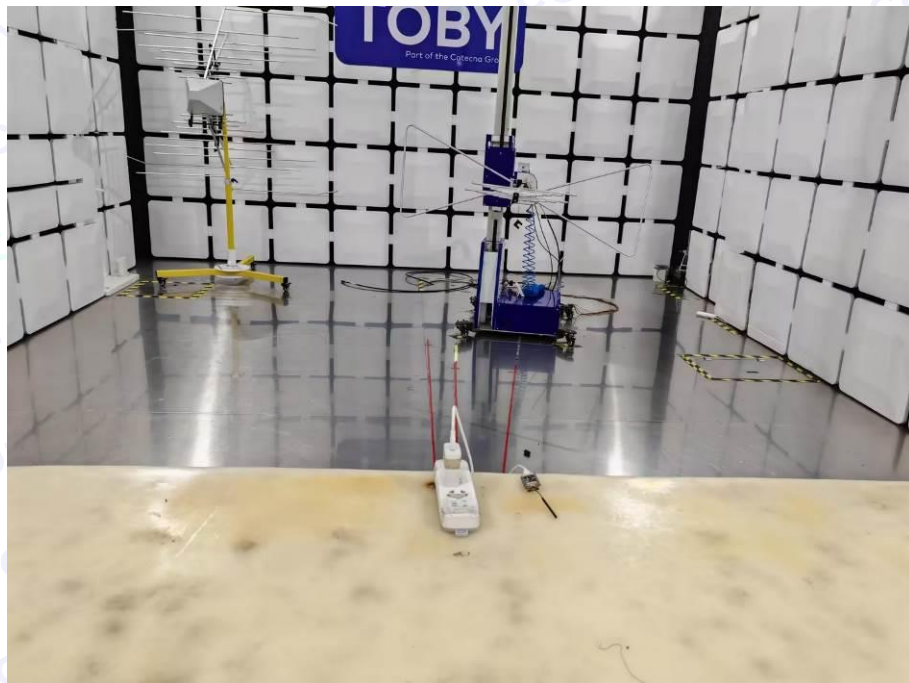

Radiated Emission Test Setup-Above 1G

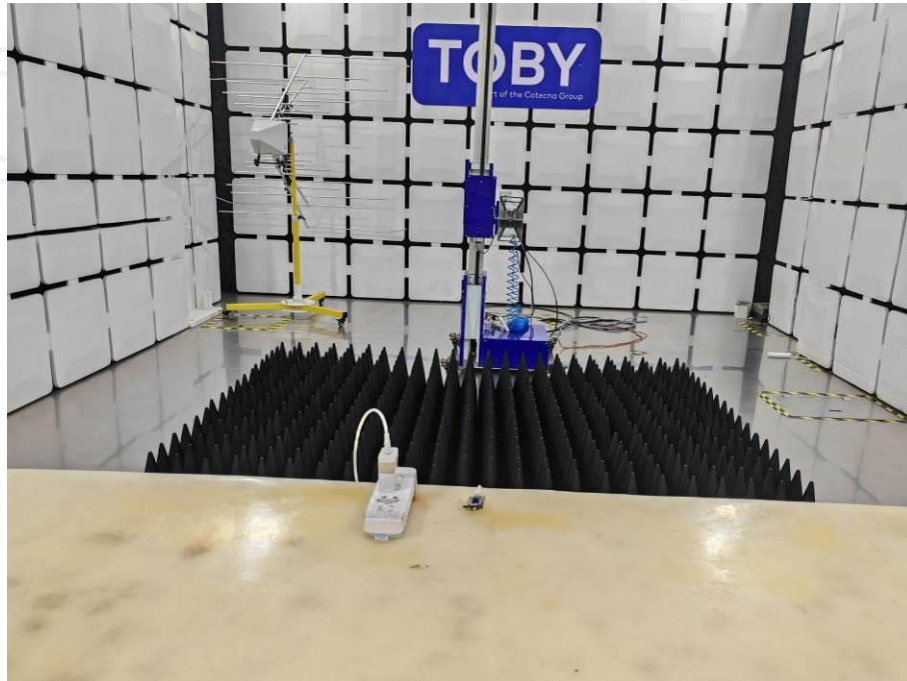

Electrostatic Discharge Test Setup

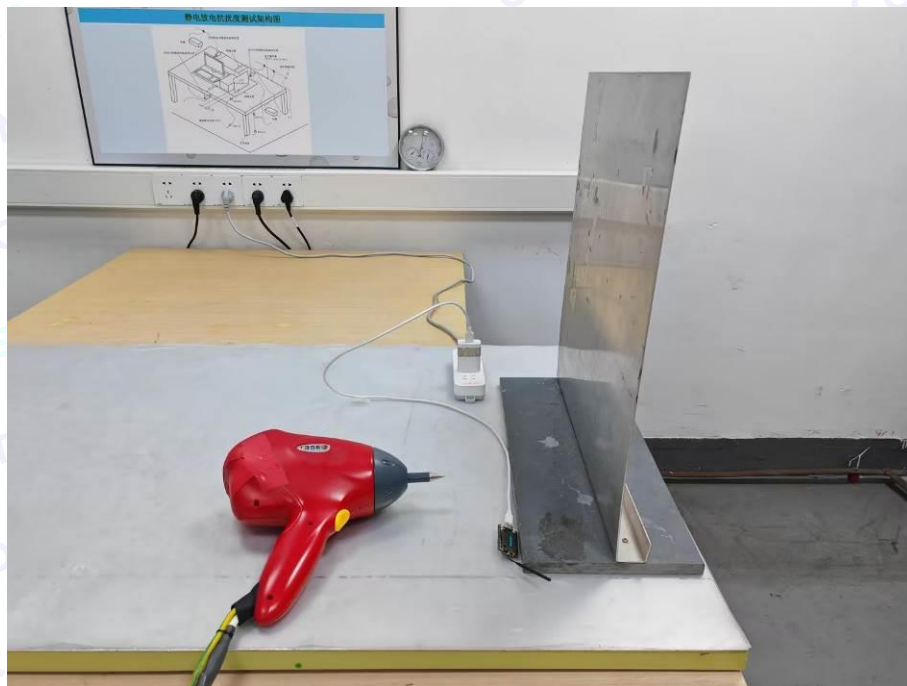

EFT, Surge, Voltage Dips Test Setup for AC Port

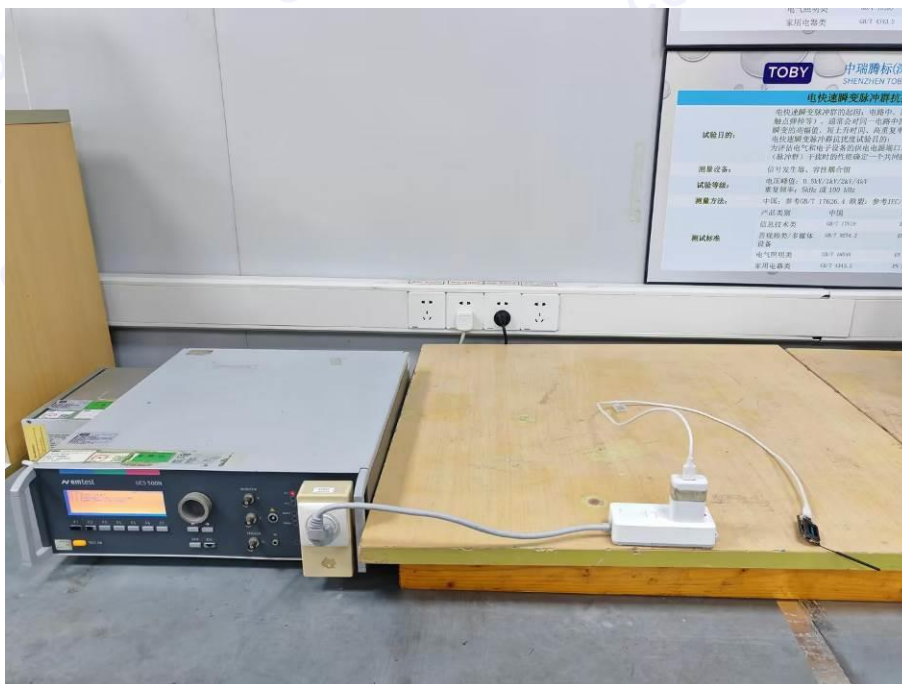

Radio-frequency, Continuous Conducted Disturbance Test Setup

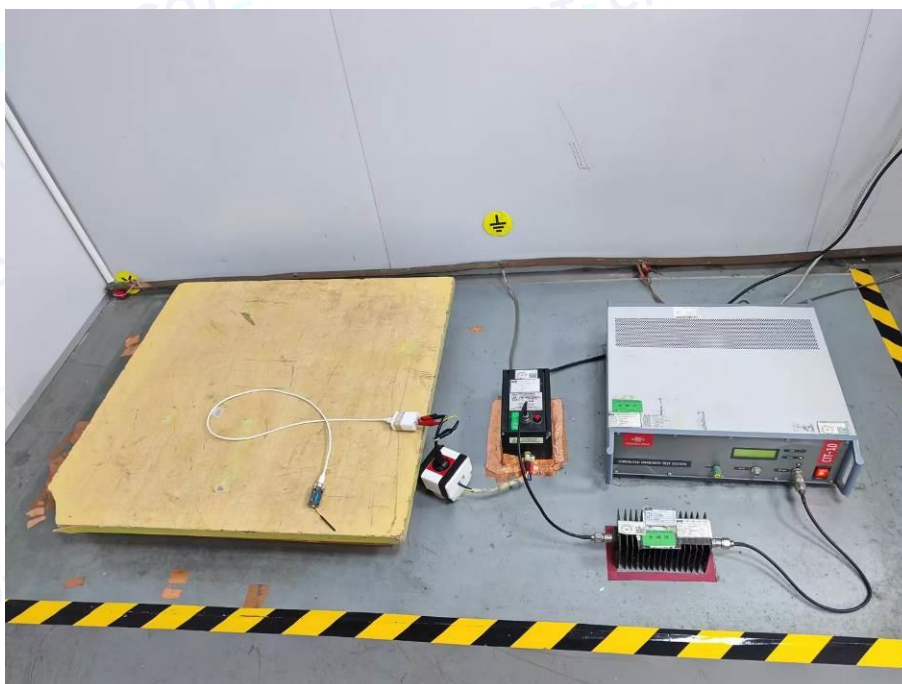

Radiated Immunity Test Setup

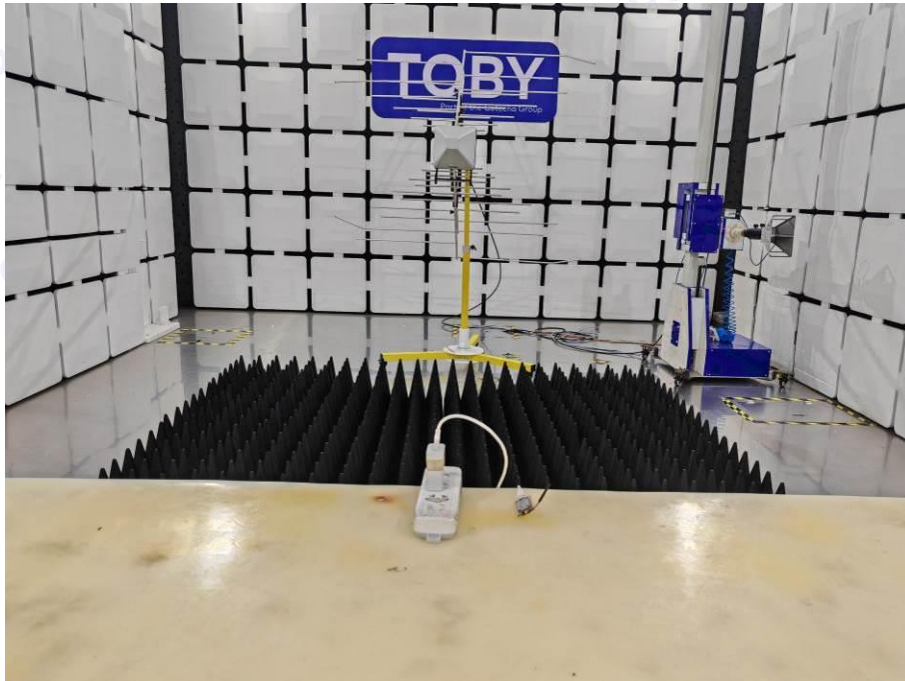

### Attachment A--Conducted Emission Data (AC Mains)

Pressure:	1020hPa
Test Voltage:	AC 230V/50Hz
Terminal:	Line
Test Mode:	Mode 1
Remark:	Only showed test data of the worst mode

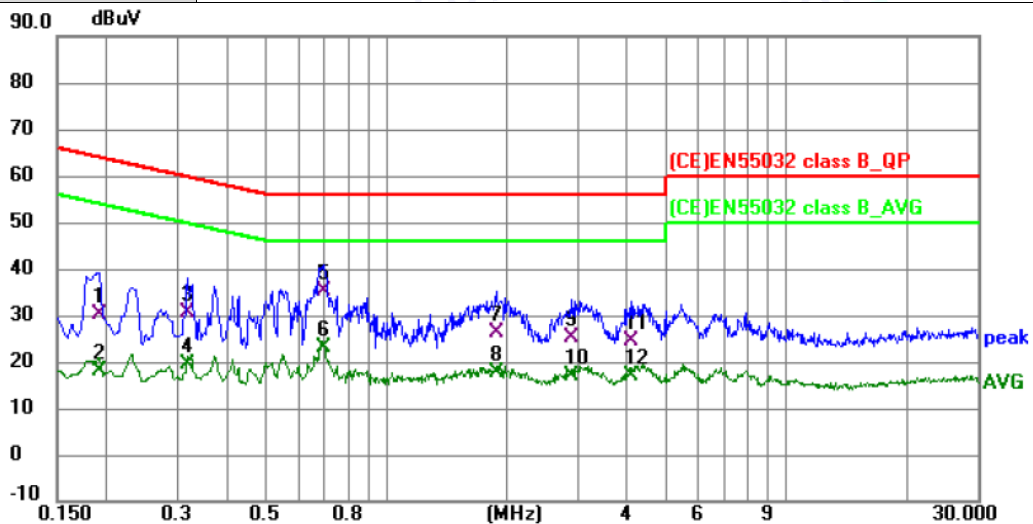

Temperature: 23.9 °C

Humidity: 49 %RH

No.	Mk.	Freq. MHz	Reading Level dBuV	Correct Factor dB	Measure- ment dBuV	Limit dBuV	Over dB	Detector
1		0.191	20.73	9.49	30.22	63.99	-33.77	QP
2		0.191	8.68	9.49	18.17	53.99	-35.82	AVG
3		0.317	20.82	9.57	30.39	59.79	-29.40	QP
4		0.317	9.92	9.57	19.49	49.79	-30.30	AVG
5	*	0.699	25.64	9.37	35.01	56.00	-20.99	QP
6		0.699	13.61	9.37	22.98	46.00	-23.02	AVG
7		1.887	16.66	9.46	26.12	56.00	-29.88	QP
8		1.887	8.29	9.46	17.75	46.00	-28.25	AVG
9		2.913	15.85	9.48	25.33	56.00	-30.67	QP
10		2.913	7.58	9.48	17.06	46.00	-28.94	AVG
11		4.106	15.04	9.43	24.47	56.00	-31.53	QP
12		4.106	7.54	9.43	16.97	46.00	-29.03	AVG

**Remark:**

1. Corr. Factor (dB) = LISN Factor (dB) + Cable Loss (dB)
2. Margin (dB) = QuasiPeak/Average (dBuV)-Limit (dBuV)



<b>Pressure:</b>	1020hPa
<b>Test Voltage:</b>	AC 230V/50Hz
<b>Terminal:</b>	Neutral
<b>Test Mode:</b>	Mode 1
<b>Remark:</b>	Only showed test data of the worst mode

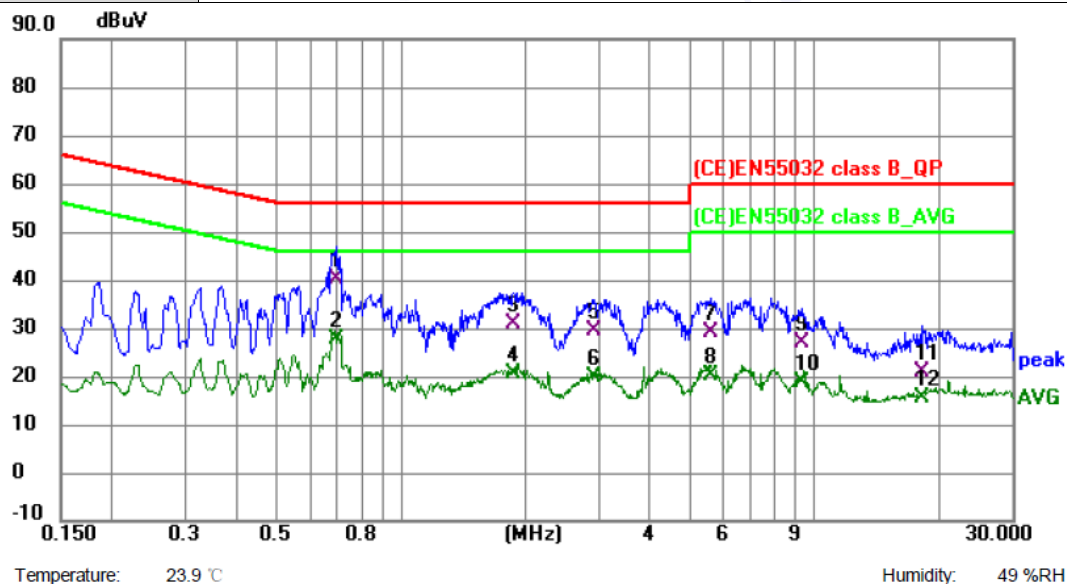

No.	Mk.	Freq. MHz	Reading Level dBuV	Correct Factor dB	Measure- ment dBuV	Limit dBuV	Over dB	Detector
1	*	0.695	30.47	9.57	40.04	56.00	-15.96	QP
2		0.695	18.19	9.57	27.76	46.00	-18.24	AVG
3		1.865	21.54	9.47	31.01	56.00	-24.99	QP
4		1.865	10.94	9.47	20.41	46.00	-25.59	AVG
5		2.922	20.01	9.46	29.47	56.00	-26.53	QP
6		2.922	10.32	9.46	19.78	46.00	-26.22	AVG
7		5.631	19.67	9.49	29.16	60.00	-30.84	QP
8		5.631	10.78	9.49	20.27	50.00	-29.73	AVG
9		9.258	17.02	9.86	26.88	60.00	-33.12	QP
10		9.258	8.95	9.86	18.81	50.00	-31.19	AVG
11		18.294	10.78	10.09	20.87	60.00	-39.13	QP
12		18.294	5.44	10.09	15.53	50.00	-34.47	AVG

**Remark:**

1. Corr. Factor (dB) = LISN Factor (dB) + Cable Loss (dB)

2. Margin (dB) = QuasiPeak/Average (dBuV) - Limit (dBuV)



## Attachment B--Radiated Emission Test Data

-----Below 1G

Pressure:	1020hPa
Test Voltage:	AC 230V/50Hz
Ant. Pol.	Horizontal
Test Mode:	Mode 1
Remark:	Only showed test data of the worst mode

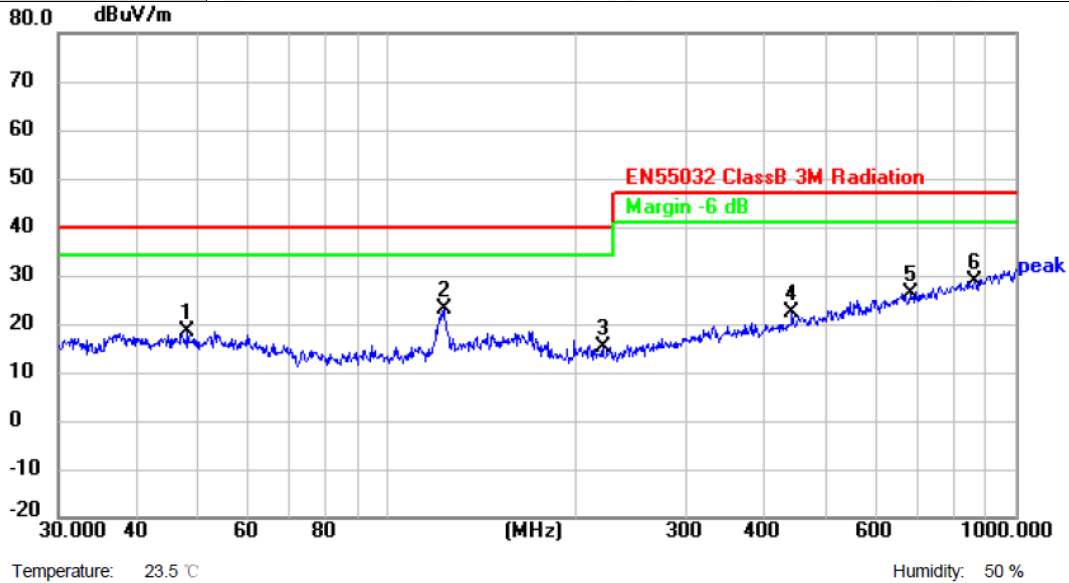

No.	Frequency (MHz)	Reading (dBuV)	Factor (dB/m)	Level (dBuV/m)	Limit (dBuV/m)	Margin (dB)	Detector	P/F
1	48.1626	41.10	-22.55	18.55	40.00	-21.45	peak	P
2 *	123.2655	45.80	-22.85	22.95	40.00	-17.05	peak	P
3	220.6171	39.75	-24.57	15.18	40.00	-24.82	peak	P
4	441.7426	39.84	-17.59	22.25	47.00	-24.75	peak	P
5	679.9600	38.39	-12.17	26.22	47.00	-20.78	peak	P
6	863.0562	38.39	-9.49	28.90	47.00	-18.10	peak	P

**Remark:**

1. Corr. = Antenna Factor (dB/m) + Cable Loss (dB)
2. QuasiPeak (dBμV/m)= Corr. (dB/m)+ Read Level (dBμV)
3. Margin (dB) = QuasiPeak (dBμV/m)-Limit QPK(dBμV/m)



Pressure:	1020hPa
Test Voltage:	AC 230V/50Hz
Ant. Pol.	Vertical
Test Mode:	Mode 1
Remark:	Only showed test data of the worst mode

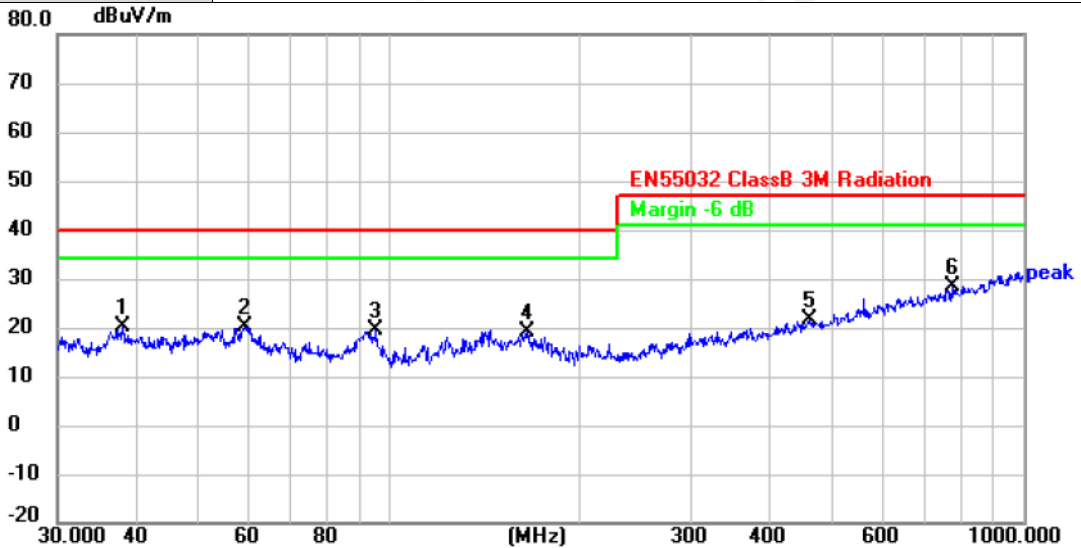

Temperature: 23.5 °C

Humidity: 50 %

No.	Frequency (MHz)	Reading (dBuV)	Factor (dB/m)	Level (dBuV/m)	Limit (dBuV/m)	Margin (dB)	Detector	P/F
1	37.9450	42.99	-22.86	20.13	40.00	-19.87	peak	P
2	59.2325	43.07	-22.75	20.32	40.00	-19.68	peak	P
3	95.4270	45.01	-25.50	19.51	40.00	-20.49	peak	P
4	164.9075	40.71	-21.52	19.19	40.00	-20.81	peak	P
5	459.1144	38.75	-17.10	21.65	47.00	-25.35	peak	P
6 *	771.4486	39.65	-11.24	28.41	47.00	-18.59	peak	P

Remark:

1. Corr. = Antenna Factor (dB/m) + Cable Loss (dB)
2. QuasiPeak (dBμV/m)= Corr. (dB/m)+ Read Level (dBμV)
3. Margin (dB) = QuasiPeak (dBμV/m)-Limit QPK(dBμV/m)



-----Above 1G

Pressure:	1020hPa
Test Voltage:	AC 230V/50Hz
Ant. Pol.	Horizontal
Test Mode:	Mode 2
Remark:	No report for the emission which below the prescribed limit.

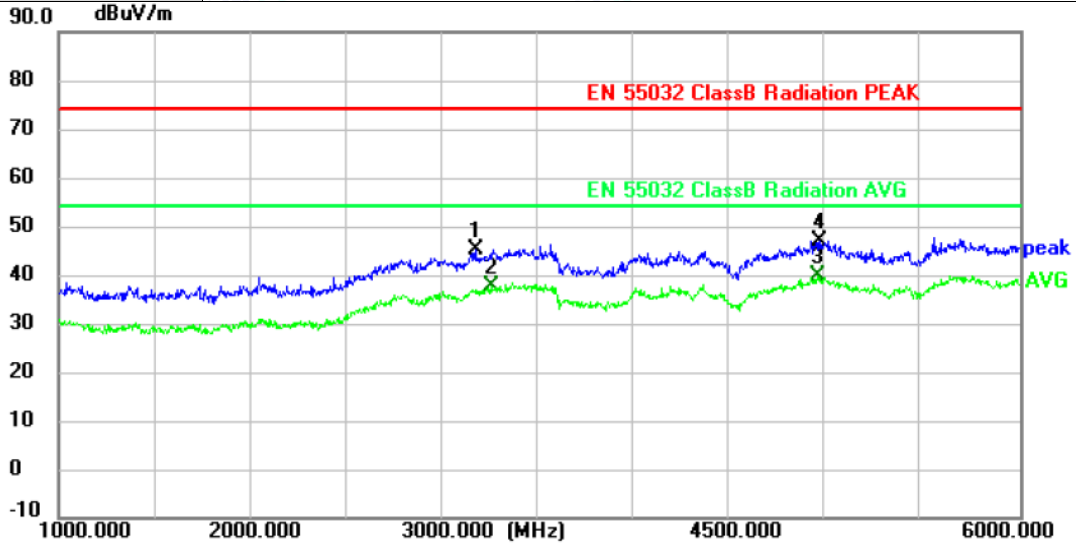

Temperature: 23.5 °C

Humidity: 51 %

No.	Frequency (MHz)	Reading (dBuV)	Factor (dB/m)	Level (dBuV/m)	Limit (dBuV/m)	Margin (dB)	Detector	P/F
1	3170.0000	53.63	-8.48	45.15	74.00	-28.85	peak	P
2	3255.0000	45.78	-8.11	37.67	54.00	-16.33	AVG	P
3 *	4945.0000	41.86	-2.11	39.75	54.00	-14.25	AVG	P
4	4955.0000	49.04	-2.11	46.93	74.00	-27.07	peak	P

Remark:

1. Corr. = Antenna Factor (dB/m) + Cable Loss (dB)
2. Peak/AVG (dBuV/m) = Corr. (dB/m) + Read Level (dBuV)
3. Margin (dB) = Peak/AVG (dBuV/m) - Limit PK/AVG (dBuV/m)



Pressure:	1020hPa
Test Voltage:	AC 230V/50Hz
Ant. Pol.	Vertical
Test Mode:	Mode 2
Remark:	No report for the emission below the prescribed limit.

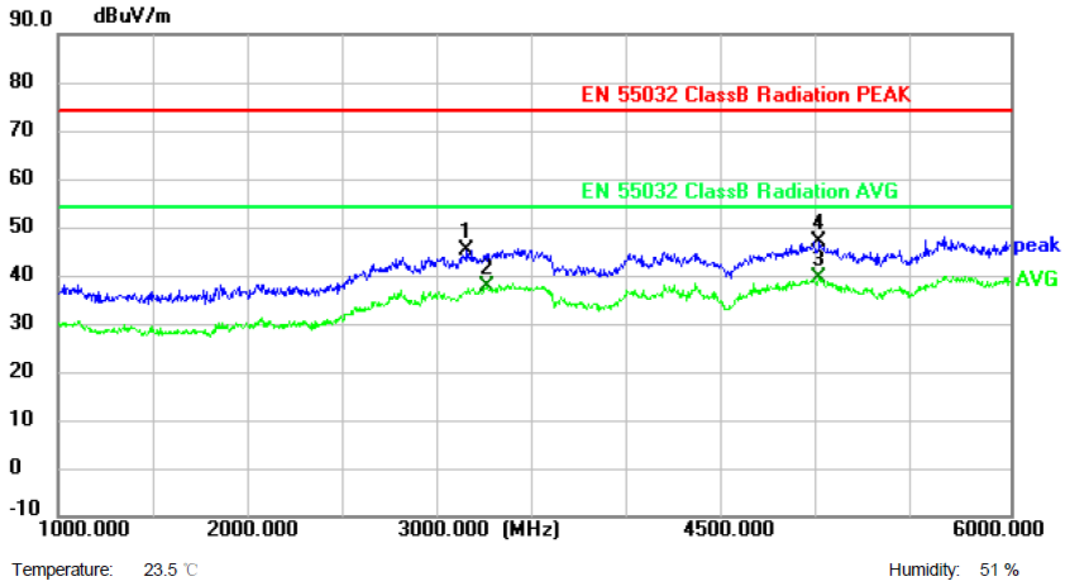

No.	Frequency (MHz)	Reading (dBuV)	Factor (dB/m)	Level (dBuV/m)	Limit (dBuV/m)	Margin (dB)	Detector	P/F
1	3145.0000	53.72	-8.48	45.24	74.00	-28.76	peak	P
2	3255.0000	45.72	-8.11	37.61	54.00	-16.39	AVG	P
3 *	4990.0000	41.62	-2.12	39.50	54.00	-14.50	AVG	P
4	4995.0000	49.05	-2.11	46.94	74.00	-27.06	peak	P

**Remark:**

1. Corr. = Antenna Factor (dB/m) + Cable Loss (dB)
2. Peak/AVG (dBμV/m) = Corr. (dB/m) + Read Level (dBμV)
3. Margin (dB) = Peak/AVG (dBμV/m) - Limit PK/AVG (dBμV/m)



### Attachment C--Electrostatic Discharge Test Data

Temperature:	23.8°C								Humidity:	46%								
Pressure(hpa):	1020																	
Power supply:	AC 230V/50Hz								Test Mode:	Mode 1/2/3								
Location	Test Level(kV) and Result																Criteria	Result
	Air Discharge								Contact Discharge									
	2		4		8		15		2		4		6		8			
	+	-	+	-	+	-	+	-	+	-	+	-	+	-	+	-		
/	/	/	/	/	/	/	/	/	/	/	/	/	/	/	/	B	PASS	
/	/	/	/	/	/	/	/	/	/	/	/	/	/	/	/	B	PASS	
/	/	/	/	/	/	/	/	/	/	/	/	/	/	/	/	B	PASS	
/	/	/	/	/	/	/	/	/	/	/	/	/	/	/	/	B	PASS	
/	/	/	/	/	/	/	/	/	/	/	/	/	/	/	/	B	PASS	
/	/	/	/	/	/	/	/	/	/	/	/	/	/	/	/	B	PASS	
Location	Test Level(kV) and Result																Criteria	Result
	HCP								VCP									
	2		4		6		8		2		4		6		8			
	+	-	+	-	+	-	+	-	+	-	+	-	+	-	+	-		
Front	A	A	A	A	/	/	/	/	A	A	A	A	/	/	/	/	B	PASS
Back	A	A	A	A	/	/	/	/	A	A	A	A	/	/	/	/	B	PASS
Left	A	A	A	A	/	/	/	/	A	A	A	A	/	/	/	/	B	PASS
Right	A	A	A	A	/	/	/	/	A	A	A	A	/	/	/	/	B	PASS
Note: "/" Representative the test not applicable																		
Criteria A: There was no change operated with initial operating during the test.																		
Criteria B: The EUT function loss during the test, but self-recoverable after the test.																		
Criteria C: The system shut down during the test.																		



Test Location Photos

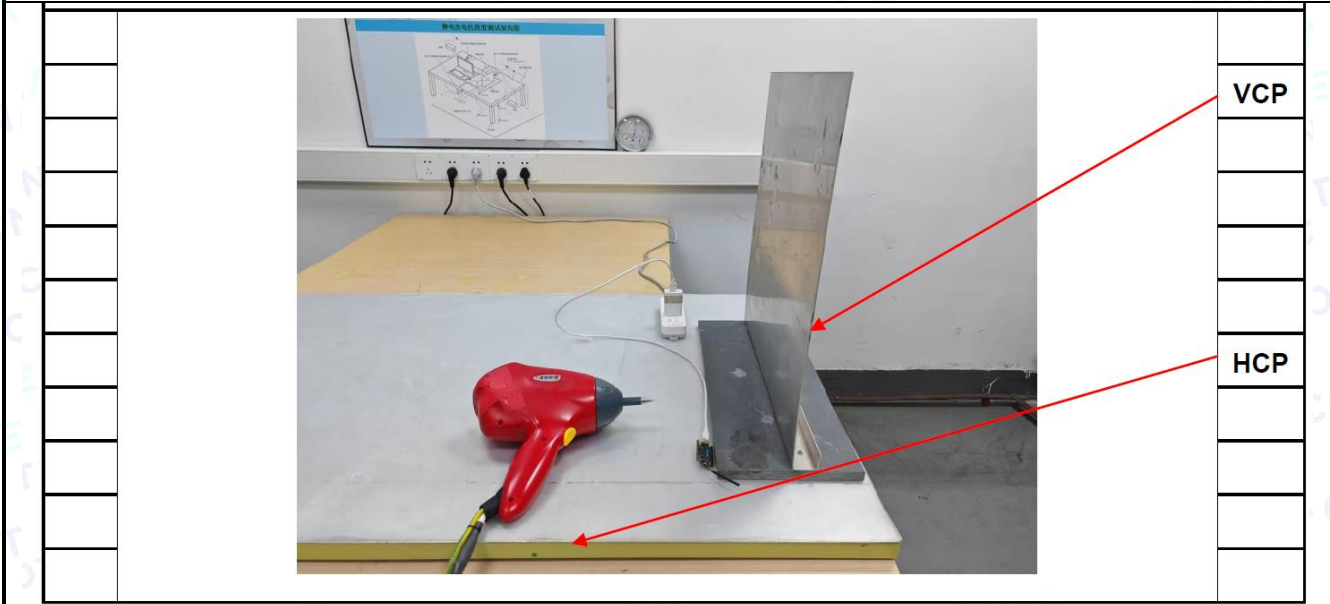

Note:

- 1) Criteria A: There was no change operated with initial operating during the test.
- 2) Criteria B: The EUT function loss during the test, but self-recoverable after the test.
- 3) Criteria C: The system shut down during the test.



## Attachment D--RF Field Strength Susceptibility Test Data

Temperature : 23.1°C Humidity : 43%					
Pressure(hpa) : 1020					
Power supply : AC 230V/50Hz Test Mode : Mode 1/2/3					
<b>Required Performance Criteria: A</b>					
Modulation: AM 80% , Field strength: 3V/m, Pulse: 1 kHz.					
EUT Position	Actual Performance Criteria				Judgment
	Frequency Range 1: 80~1000MHz		Frequency Range 2: 1000~6000MHz		
	Horizontal	Vertical	Horizontal	Vertical	
Front	A	A	A	A	PASS
Right	A	A	A	A	PASS
Rear	A	A	A	A	PASS
Left	A	A	A	A	PASS



### Attachment E--Electrical Fast Transient/Burst Test Data

Temperature : 23.8°C		Humidity : 46%					
Pressure(hpa) : 1020							
Power supply : AC 230V/50Hz		Test Mode : Mode 1/2/3					
<b>Required Performance Criteria: B</b>							
Line	Voltage(kV)	Required Performance Criteria		Actual Performance Criteria		Judgment	
		(+)	(-)	(+)	(-)		
AC LINE	L	1.0	B	B	A	A	PASS
	N	1.0	B	B	A	A	PASS
	L-N	1.0	B	B	A	A	PASS
	PE	1.0	/	/	/	/	/
	L-PE	1.0	/	/	/	/	/
	N-PE	1.0	/	/	/	/	/
	L-N-PE	1.0	/	/	/	/	/
RJ 45 Port	0.5	/	/	/	/	/	/
<b>Remark:</b>							
1) Criteria A: There was no change operated with initial operating during the test. 2) Criteria B: The EUT function loss during the test, but self-recoverable after the test. 3) Criteria C: The system shut down during the test.							



### Attachment F--Surge Immunity Test Data

Temperature : 23.8°C		Humidity : 46%				
Pressure(hpa) : 1020						
Power supply : AC 230V/50Hz			Test Mode : Mode 1/2/3			
<b>Required Performance Criteria: B</b>						
<b>(Tr/Th: 1.2/50us for AC Power Port; Tr/Th: 10/700us for signal lines)</b>						
Injected Line	Voltage (kV)	Phase	Actual Performance Criteria		Result	
			(+)	(-)	(+)	(-)
L-N	1.0	0°	A	A	PASS	PASS
		90°	A	A	PASS	PASS
		180°	A	A	PASS	PASS
		270°	A	A	PASS	PASS
L-PE	2.0	0°	/	/	/	/
		90°	/	/	/	/
		180°	/	/	/	/
		270°	/	/	/	/
N-PE	2.0	0°	/	/	/	/
		90°	/	/	/	/
		180°	/	/	/	/
		270°	/	/	/	/
RJ 45Port	1.0	+/-	/	/	/	/



## Attachment G--Conducted Immunity Test Data

Temperature	: 23.8°C	Humidity	: 46%		
Pressure(hpa)	: 1020				
Power supply	: AC 230V/50Hz	Test Mode	: Mode 1/2/3		
<b>Required Performance Criteria: A</b>					
Frequency Range (MHz)	Injected Position	Voltage Level (e.m.f.)	Required Performance Criteria	Actual Performance Criteria	Result
0.15 ~ 80	AC Mains	3V(rms), AM 80% Modulated with 1 kHz	A	A	PASS
0.15 ~ 80	RJ 11	3V(rms), AM 80% Modulated with 1 kHz	A	/	/
0.15 ~ 80	Wired Network Port	3V(rms), AM 80% Modulated with 1 kHz	A	/	/



## Attachment H--Voltage Dips and Interruptions Test Data

Temperature :	23.8℃	Humidity :	46%	
Pressure(hpa):	1020			
Power Supply :	AC 230V/50Hz	Test Mode :	Mode 1/2/3	
<b>Required Performance Criteria: B&amp;C</b>				
Test Results Description				
Voltage Reduction	Cycles	Required Performance Criteria	Actual Performance Criteria	Judgment
Voltage dip 100%	0.5	B	B	PASS
Voltage dip 100%	1	B	B	PASS
Voltage dip 30%	25	C	C	PASS
Voltage Interruption100%	250	C	C	PASS
Remark: Criteria A: There was no change operated with initial operating during the test. Criteria B: The EUT function loss during the test, but self-recoverable after the test. Criteria C: The system shut down during the test.				

-----END OF THE REPORT-----

